







2015



Profilübersichten

profile systems

Legende · Legend

-  **PVC weiß oder farbig durchgefärbt** · uPVC white or solid-coloured
-  **foliiert** · laminated
-  **PMMA außen farbig, auf PVC Grundkörper** · PMMA colour on uPVC
-  **PVC Profil mit Recyclingkern** · uPVC profile with recycling core
-  **Statische-Trocken-Verglasung STV®** · STV® static dry glazing
-  **Intensiv-Kern-Dämmung IKD®** · IKD® intensive core insulation
-51 **Stahl** · steel
-52 **Aluminium** · aluminium
-55 **Zinkdruckguss** · zinc diecasting
-70 **Kunststoffzubehör** · plastics accessories
-80 **Polyamid-Zubehör** · polyamide accessories
-90 **EPDM Dichtung** · EPDM gasket
-91 **Silikon** · silicone
-92 **TPE Dichtung** · TPE gasket
-93 **PVC weich** · Flexible PVC
-99 **Sonstige Materialien und Fensterzubehör** · other materials and window accessories
- **Profiloberfläche mit Dekor- oder Farbfolie** · surface laminated with wooden-structure or coloured film
- **PMMA-Oberfläche coextrudiert** · PMMA surface, c oextruded
- Ix und Iy Werte in cm⁴** · Ix and Iy value in cm⁴
-  **grau angelegte Profile in Vorbereitung** · grey profiles in process of realisation

Hinweis:

Der Inhalt dieser Profilübersicht ist unverbindlich! Das exakte Lieferprogramm entnehmen Sie bitte der aktuellen Übersicht „Profile und Zubehör“.

Please note:

The content of this compendium is not binding! See the exact product range in the summary „Profiles and Accessories“.

S 3000 Blendrahmen · Frames

S 3000

S 7000 IQ
S 7000 IQ plus

S 8000 IQ

S 9000

NL plus

Stulp

Sprossen

Glasleisten

Aussteifungen

Dichtungen

Rahmenverbreiterungen

Kopplungsprofile

Eckprofile

Verleistungen

Untere Anschlussprofile

Laibungsverkleidungen

Schwellen

Lüftungssystem

Hebeschiebesysteme

Schiebesysteme

Rollladen / Cassonetto

RAE plus

Klappladen

Sonstiges

5-Kammer

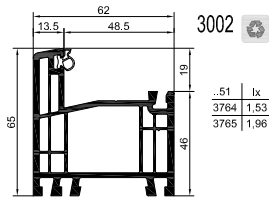

3002

..51	lx	ly	Typ	d
3764	1,53	0,81	n	1,50
3765	1,96	1,06	n	2,00

S 3000 Pfosten · Mullions

3-Kammer

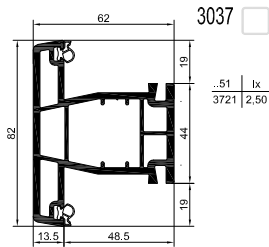

3037

..51	lx	ly	Typ	d
3721	2,50	1,70	□	2,00



3492₇₀ †
3493₇₀ †

3477₅₁

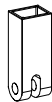

3413₈₀



3473₅₅

S 3000 Flügel · Sashes

2-Kammer

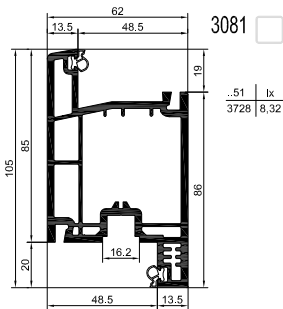

3081

..51	lx	ly	Typ	d
3728	8,32	7,48	□	2,00

5-Kammer

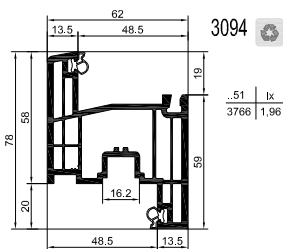

3094

..51	lx	ly	Typ	d
3766	1,96	1,10	n	1,50

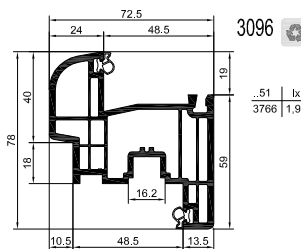

3096

..51	lx	ly	Typ	d
3766	1,96	1,10	n	1,50

S 7000 IQ Blendrahmen · Frames

S 3000

5-Kammer

S 7000 IQ
S 7000 IQ plus

S 8000 IQ

S 9000

NL plus

Stulp

Sprossen

Glasleisten

Aussteifungen

Dichtungen

Rahmenverbreiterungen

Kopplungsprofile

Eckprofile

Verleistungen

Untere Anschlussprofile

Laibungsverkleidungen

Schwellen

Lüftungssystem

Hebeschiebesysteme

Schiebesysteme

Rollladen / Cassonetto

RAE plus

Klappladen

Sonstiges

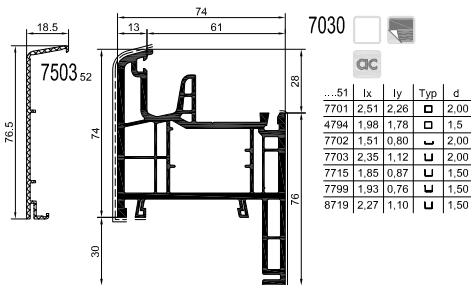
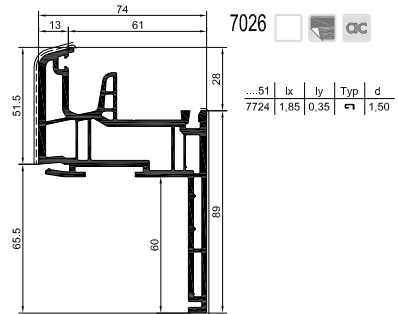
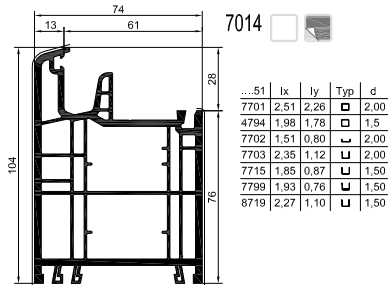
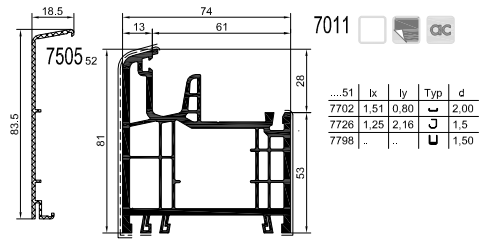
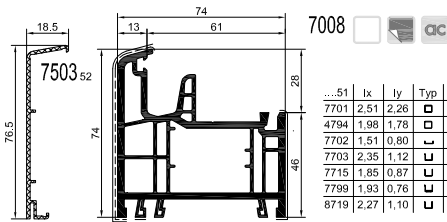

S 7000 IQ plus Blendrahmen · Frames

6-Kammer

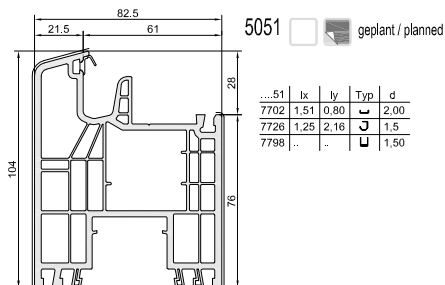
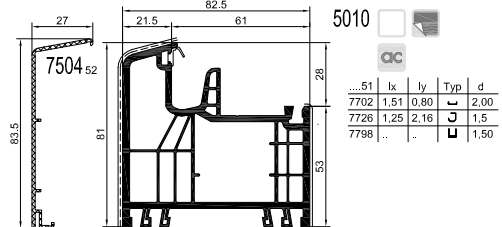
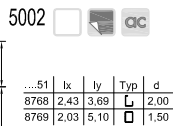

S 7000 IQ Pfosten · Mullions

3-Kammer

7510 ⁵²

7037

...51	lx	ly	Typ	d
7705	5,80	1,97	□	2,00
7719	4,02	1,92	□	2,00

7492 ₇₀

7490 ₇₀

7491 ₇₀

7411 ₈₀

7161 _{90 S}

3476 ₅₁

7509 ⁵²

7043

...51	lx	ly	Typ	d
7722	12,03	11,48	□	2,50

7493 ₇₀

7479 ₅₁

7161 _{90 S}

S 7000 IQ plus Pfosten · Mullions

4-Kammer

5404 ⁵²

5006

...51	lx	ly	Typ	d
7722	12,03	11,48	□	2,50

7493 ₇₀

7479 ₅₁

7161 _{90 S}

5419 ⁵²

5013

...51	lx	ly	Typ	d
7705	5,80	1,97	□	2,00
7719	4,02	1,92	□	2,00

7492 ₇₀

7490 ₇₀

7491 ₇₀

7411 ₈₀

7161 _{90 S}

3476 ₅₁

- S 3000
- S 7000 IQ**
- S 7000 IQ plus**
- S 8000 IQ
- S 9000
- NL plus
- Stulp
- Sprossen
- Glasleisten
- Aussteifungen
- Dichtungen
- Rahmenverbreiterungen
- Kopplungsprofile
- Eckprofile
- Verleistungen
- Untere Anschlussprofile
- Laibungsverkleidungen
- Schwellen
- Lüftungssystem
- Hebeschiebesysteme
- Schiebesysteme
- Rollladen / Cassonetto
- RAE plus
- Klappladen
- Sonstiges

S 8000 IQ Blendrahmen · Frames

4-Kammer

8013

...51	lx	ly	Typ	d
8705	4,78	6,21		2,00
8707	3,90	0,43		2,00
8714	4,78	5,86		1,50

8014

...51	lx	ly	Typ	d
8701	5,92	2,87		2,00
8703	5,51	1,80		2,00
8751	4,50	2,25		1,50
8753	4,27	1,40		1,50
8757	2,60	1,18		1,50
8758	3,38	1,52		2,00

8015

...51	lx	ly	Typ	d
8701	5,92	2,87		2,00
8703	5,51	1,80		2,00
8705	4,78	6,21		2,00
8751	4,50	2,25		1,50
8753	4,27	1,40		1,50
8757	2,60	1,18		1,50
8758	3,38	1,52		2,00

S 3000

S 7000 IQ
S 7000 IQ plus

S 8000 IQ

S 9000

NL plus

Stulp

Sprossen

Glasleisten

Aussteifungen

Dichtungen

Rahmenverbreiterungen

Kopplungsprofile

Eckprofile

Verleistungen

Untere Anschlussprofile

Laibungsverkleidungen

Schwellen

Lüftungssystem

Hebeschiebesysteme

Schiebesysteme

Rollladen / Cassonetto

RAE plus

Klappladen

Sonstiges

5-Kammer

8006

...51	lx	ly	Typ	d
8701	5,92	2,87		2,00
8703	5,51	1,80		2,00
8751	4,50	2,25		1,50
8753	4,27	1,40		1,50
8757	2,60	1,18		1,50
8758	3,38	1,52		2,00

8012

...51	lx	ly	Typ	d
8705	4,78	6,21		2,00
8707	3,90	0,43		2,00
8714	4,78	5,86		1,50

6-Kammer

8001

...51	lx	ly	Typ	d
8715	1,90	1,90		1,50
8716	1,74	1,05		1,50
8727	2,20	1,35		2,00

8010

...51	lx	ly	Typ	d
8710	2,65	3,95		2,00
8764	1,50	0,31		2,00

Monoblock-Blendrahmen

5500

...51	lx	ly	Typ	d
8715	1,90	1,90		1,50
8716	1,74	1,05		1,50
8727	2,20	1,35		2,00

5501

...51	lx	ly	Typ	d
8715	1,90	1,90		1,50
8716	1,74	1,05		1,50
8727	2,20	1,35		2,00

S 8000 IQ Blendrahmen · Frames

Monoblock-Blendrahmen

S 3000

S 7000 IQ
S 7000 IQ plus

S 8000 IQ

S 9000

NL plus

Stulp

Sprossen

Glasleisten

Aussteifungen

Dichtungen

Rahmenverbreiterungen

Kopplungsprofile

Eckprofile

Verleistungen

Untere Anschlussprofile

Laibungsverkleidungen

Schwellen

Lüftungssystem

Hebeschiebesysteme

Schiebesysteme

Rollladen / Cassonetto

RAE plus

Klappladen

Sonstiges

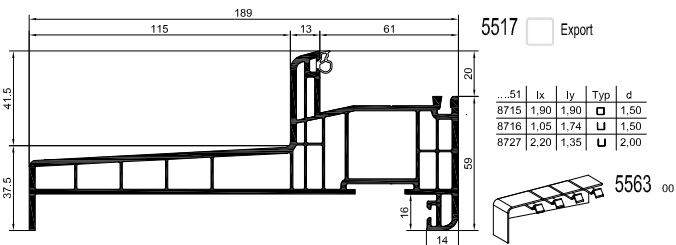
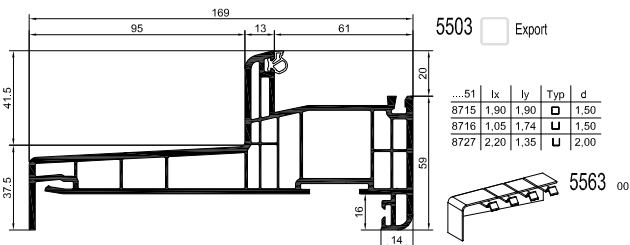
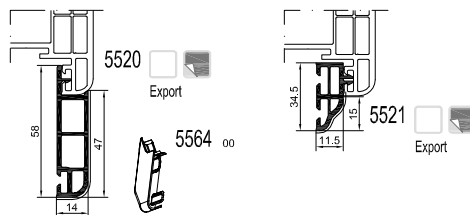
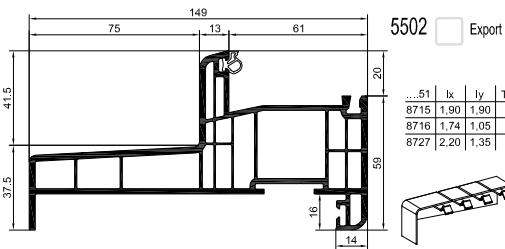

4-Kammer Reno-Blendrahmen

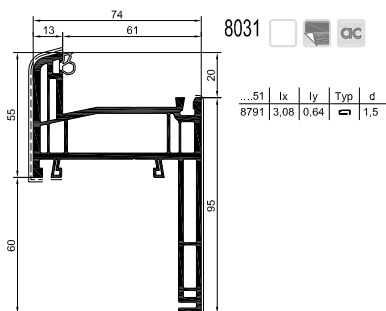
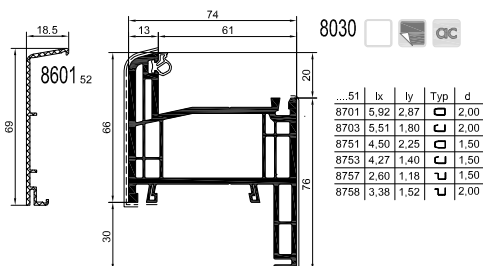
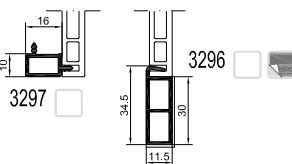
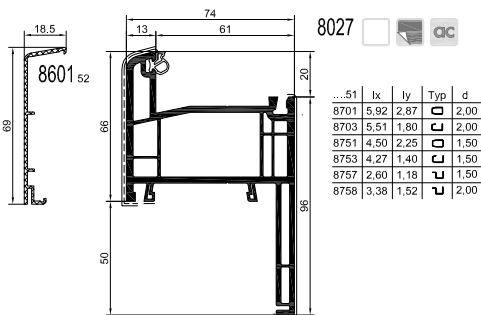
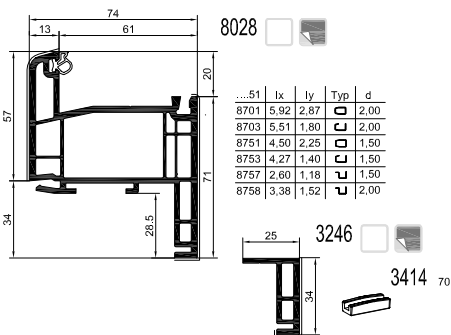

S 8000 IQ Blendrahmen · Frames

6-Kammer Reno-Blendrahmen

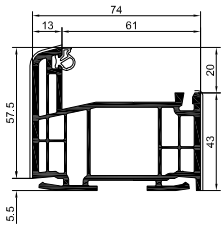

5505 Export

...51	lx	ly	Typ	d
8715	1,90	1,90	□	1,50
8716	1,74	1,05	U	1,50
8727	2,20	1,35	U	2,00

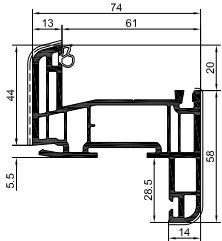

5516 Export

...51	lx	ly	Typ	d
3702	1,61	0,53	□	2,00
3704	1,11	0,18	U	1,50
8764	1,50	0,31	U	2,00
8760	1,47	0,60	□	1,50

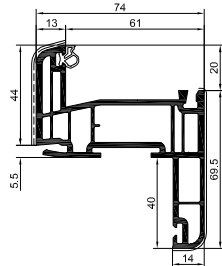

5507 Export

...51	lx	ly	Typ	d
3702	1,61	0,53	□	2,00
3704	1,11	0,18	U	1,50
8764	1,50	0,31	U	2,00
8760	1,47	0,60	□	1,50

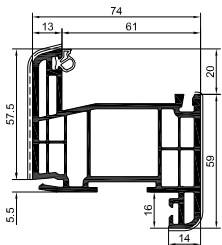

5504 Export

...51	lx	ly	Typ	d
8715	1,90	1,90	□	1,50
8716	1,74	1,05	U	1,50
8727	2,20	1,35	U	2,00

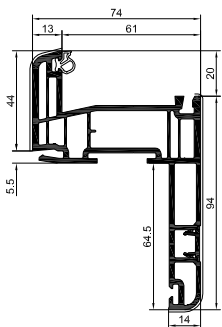

5515 Export

...51	lx	ly	Typ	d
3702	1,61	0,53	□	2,00
3704	1,11	0,18	U	1,50
8764	1,50	0,31	U	2,00
8760	1,47	0,60	□	1,50

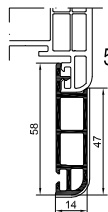

5520 Export



5564 Export

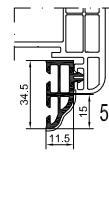

5521 Export

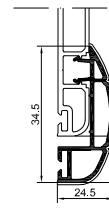

5518 Export



5565 Export

- S 3000
- S 7000 IQ
- S 7000 IQ plus
- S 8000 IQ**
- S 9000
- NL plus
- Stulp
- Sprossen
- Glasleisten
- Aussteifungen
- Dichtungen
- Rahmenverbreiterungen
- Kopplungsprofile
- Eckprofile
- Verleistungen
- Untere Anschlussprofile
- Laibungsverkleidungen
- Schwellen
- Lüftungssystem
- Hebeschiebesysteme
- Schiebesysteme
- Rollladen / Cassonetto
- RAE plus
- Klappladen
- Sonstiges

S 8000 IQ Pfosten · Mullions

3-Kammer

S 3000

S 7000 IQ
S 7000 IQ plus

S 8000 IQ

S 9000

NL plus

Stulp

Sprossen

Glasleisten

Aussteifungen

Dichtungen

Rahmenverbreiterungen

Kopplungsprofile

Eckprofile

Verleistungen

Untere Anschlussprofile

Laibungsverkleidungen

Schwellen

Lüftungssystem

Hebeschiebesysteme

Schiebesysteme

Rollladen / Cassonetto

RAE plus

Klappläden

Sonstiges

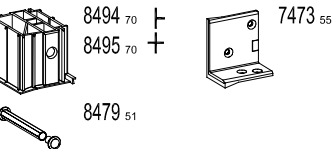
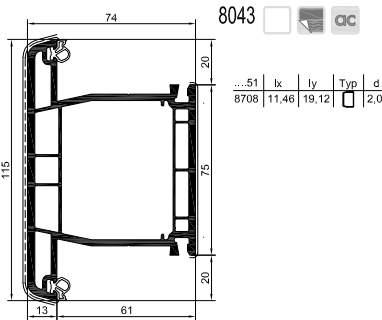
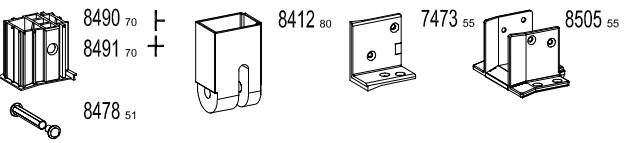
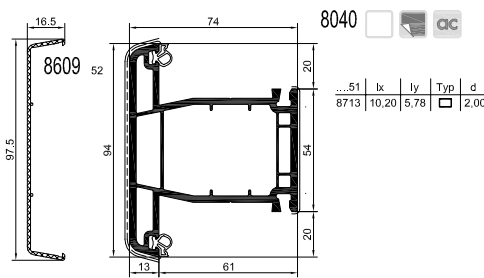
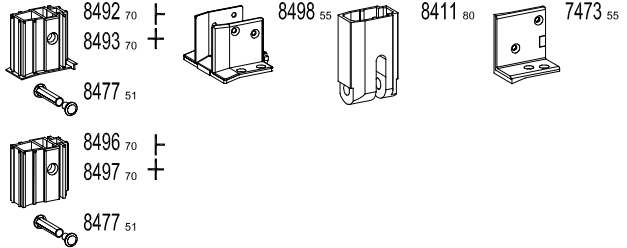
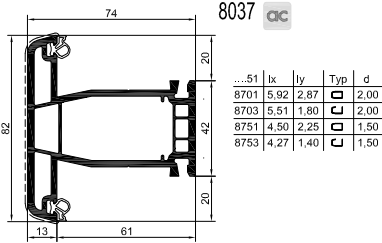
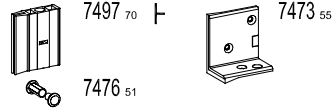
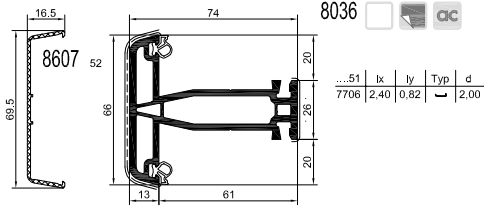

5-Kammer

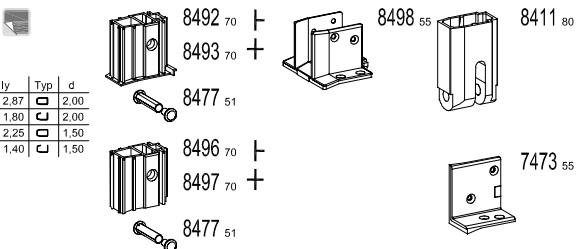
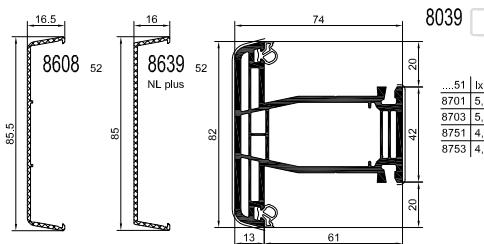
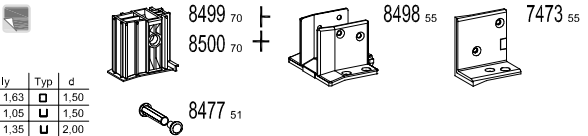
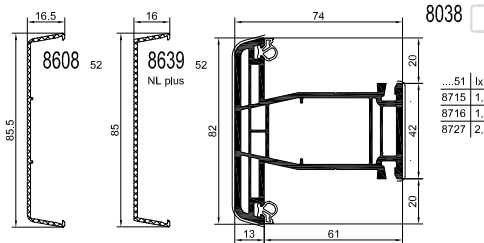

S 8000 IQ Pfosten · Mullions

4-Kammer Wechselfosten

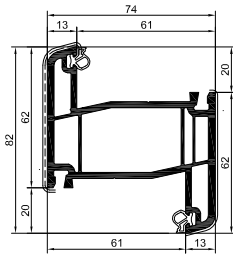

8056



.51	lx	ly	Typ	d
8777	4,12	1,34	C	1,50

S 3000

S 7000 IQ
S 7000 IQ plus

S 8000 IQ

S 9000

NL plus

Stulp

Sprossen

Glasleisten

Aussteifungen

Dichtungen

Rahmenverbreiterungen

Kopplungsprofile

Eckprofile

Verleistungen

Untere Anschlussprofile

Laibungsverkleidungen

Schwellen

Lüftungssystem

Hebeschiebesysteme

Schiebesysteme

Rollladen / Cassonetto

RAE plus

Klappladen

Sonstiges

S 8000 IQ Flügel · Sashes

S 3000

4-Kammer

S 7000 IQ
S 7000 IQ plus

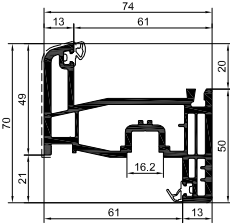
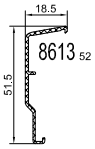

8072

...51	lx	ly	Typ	d
8724	3,55	0,59		2,00

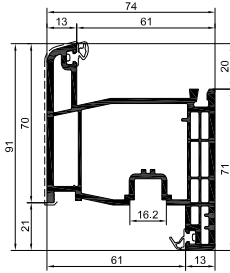

8097 Export

...51	lx	ly	Typ	d
8709	5,46	8,71		2,00
8790	4,17	4,42		2,00

S 8000 IQ

S 9000

NL plus

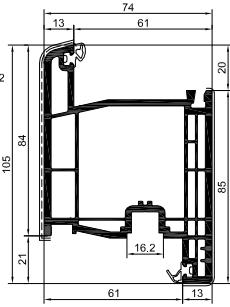
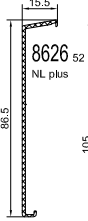
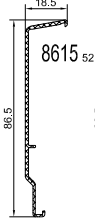

8081

...51	lx	ly	Typ	d
8706	10,60	9,22		2,00

Stulp

Sprossen

Glasleisten

Aussteifungen

Dichtungen

Rahmenverbreiterungen

Kopplungsprofile

Eckprofile

Verleistungen

Untere Anschlussprofile

Laibungsverkleidungen

Schwellen

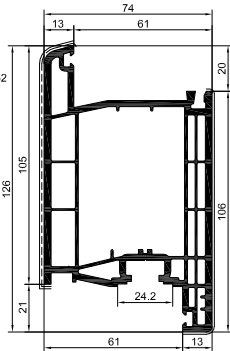
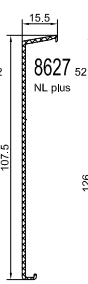

8076

...51	lx	ly	Typ	d
8736	13,83	20,88		2,00

...52	lx	ly	Typ	d
8732	16,81	27,51		2,00

8441 70

8732 52

8733 52

8443 70

8736 51

8737 51

3158 99

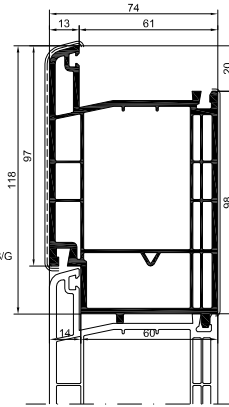

8273

...51	lx	ly	Typ	d
8736	13,83	20,88		2,00

8177 92 S/G

5-Kammer

Lüftungssystem

Hebeschiebesysteme

Schiebesysteme

Rollladen / Cassonetto

RAE plus

Klappladen

Sonstiges

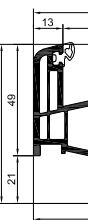
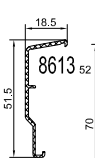

8079

...51	lx	ly	Typ	d
8724	3,55	0,59		2,00

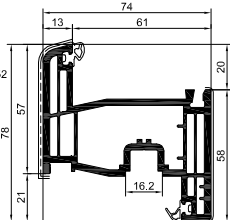
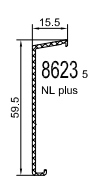
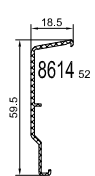

8092

...51	lx	ly	Typ	d
8703	5,51	1,80		2,00
8704	4,00	1,44		2,00
8753	4,27	1,40		1,50
8754	3,11	1,13		1,50
8757	2,60	1,18		1,50
8758	3,38	1,52		2,00

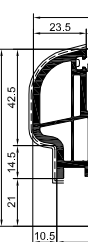

8068

...51	lx	ly	Typ	d
8703	5,51	1,80		2,00
8704	4,00	1,44		2,00
8753	4,27	1,40		1,50
8754	3,11	1,13		1,50
8757	2,60	1,18		1,50
8758	3,38	1,52		2,00

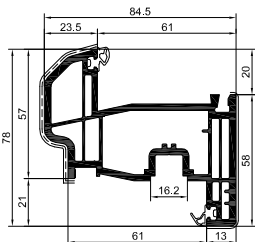

8063

...51	lx	ly	Typ	d
8703	5,51	1,80		2,00
8704	4,00	1,44		2,00
8753	4,27	1,40		1,50
8754	3,11	1,13		1,50
8757	2,60	1,18		1,50
8758	3,38	1,52		2,00

S 8000 IQ Flügel · Sashes

6-Kammer

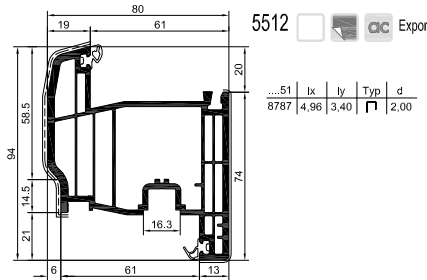
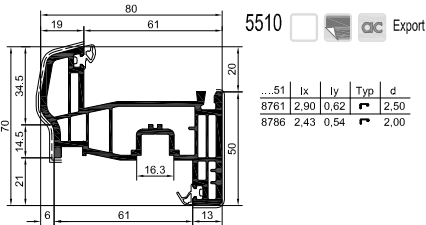
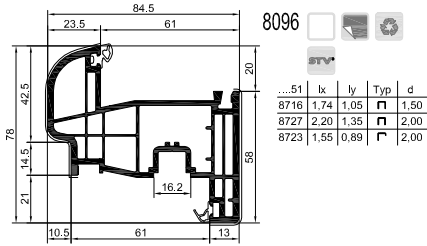
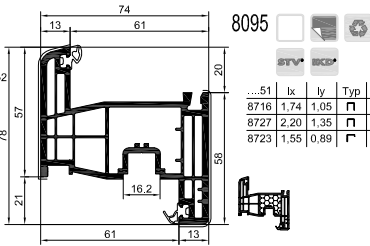
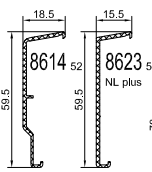

4-Kammer außenöffnend

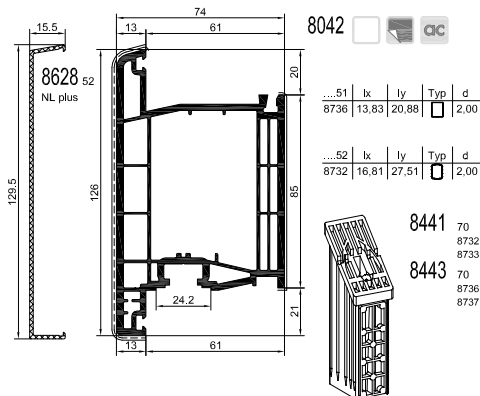
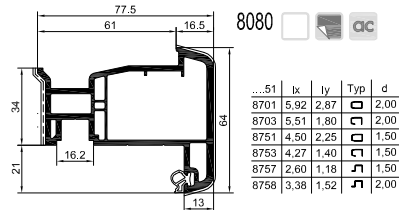
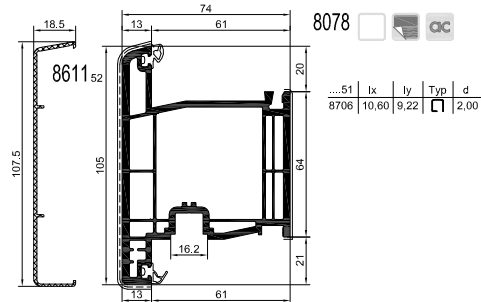
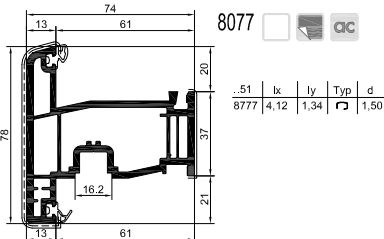

- 8441 70
- 8732 52
- 8733 52
- 8443 70
- 8736 51
- 8737 51

8177 92 S/G

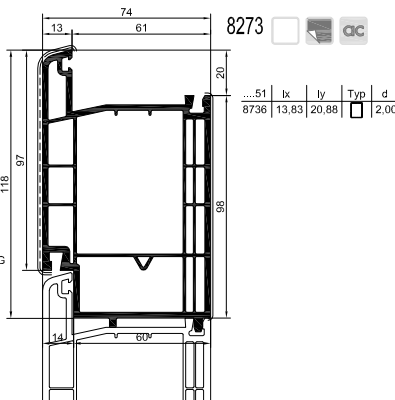

S 3000

S 7000 IQ
S 7000 IQ plus

S 8000 IQ

S 9000

NL plus

Stulp

Sprossen

Glasleisten

Aussteifungen

Dichtungen

Rahmenverbreiterungen

Kopplungsprofile

Eckprofile

Verleistungen

Untere Anschlussprofile

Laibungsverkleidungen

Schwellen

Lüftungssystem

Hebeschiebesysteme

Schiebesysteme

Rollladen / Cassonetto

RAE plus

Klappladen

Sonstiges

S 9000 Blendrahmen · Frames

6-Kammer

S 3000

S 7000 IQ
S 7000 IQ plus

S 8000 IQ

S 9000

NL plus

Stulp

Sprossen

Glasleisten

Aussteifungen

Dichtungen

Rahmenverbreiterungen

Kopplungsprofile

Eckprofile

Verleistungen

Untere Anschlussprofile

Laibungsverkleidungen

Schwellen

Lüftungssystem

Hebeschiebesysteme

Schiebesysteme

Rollladen / Cassonetto

RAE plus

Klappladen

Sonstiges

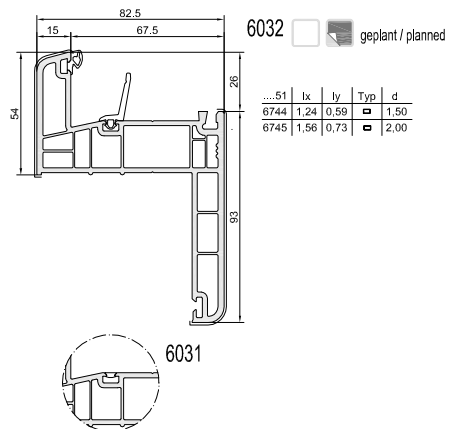
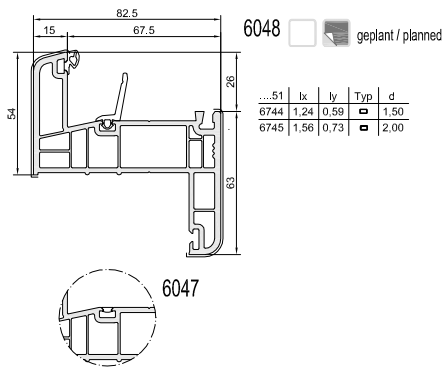
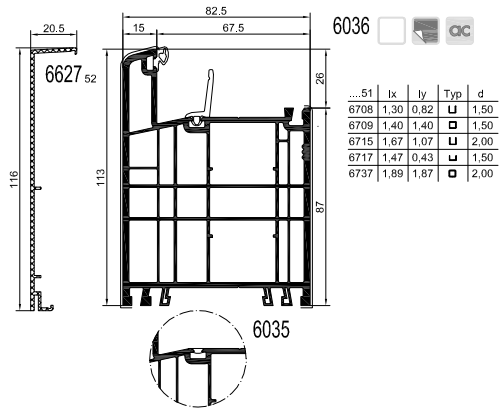
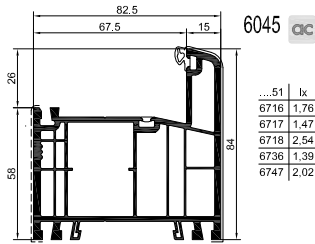
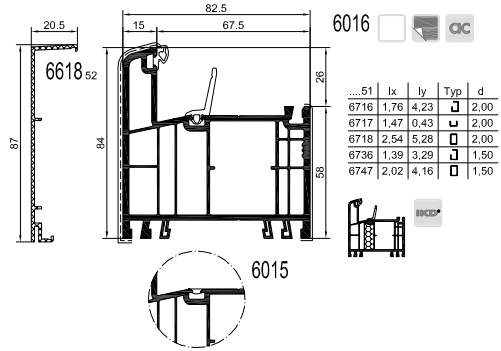
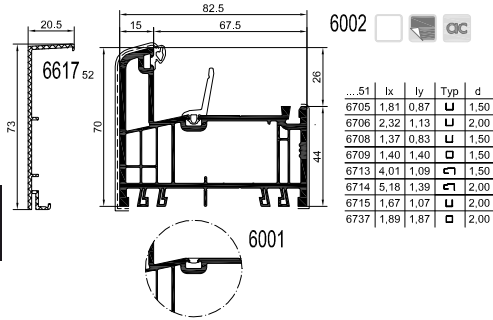

S 9000 Flügel - Sashes

S 3000

6-Kammer

S 7000 IQ
S 7000 IQ plus

S 8000 IQ

S 9000

NL plus

Stulp

Sprossen

Glasleisten

Aussteifungen

Dichtungen

Rahmenverbreiterungen

Kopplungsprofile

Eckprofile

Verleistungen

Untere Anschlussprofile

Laibungsverkleidungen

Schwellen

Lüftungssystem

Hebeschiebesysteme

Schiebesysteme

Rollladen / Cassonetto

RAE plus

Klappladen

Sonstiges

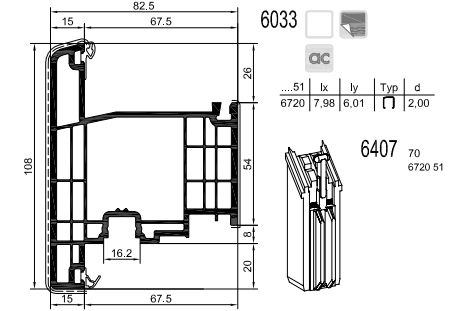
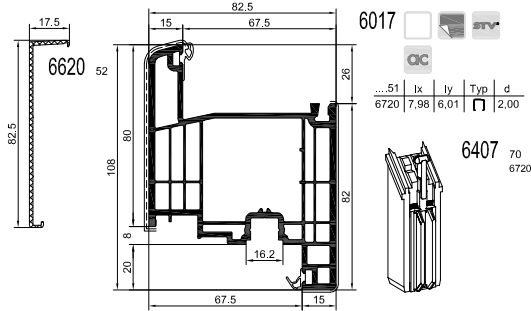
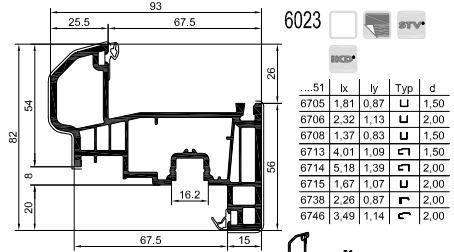
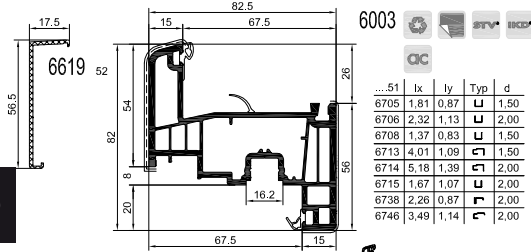

5-Kammer Haustür

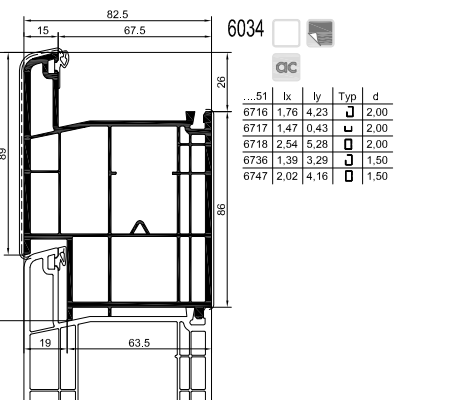
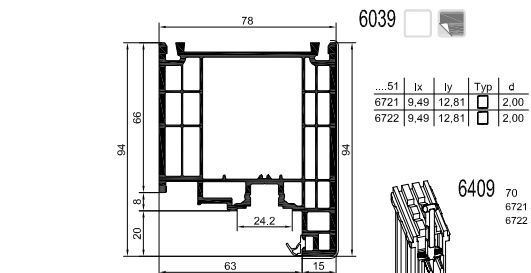
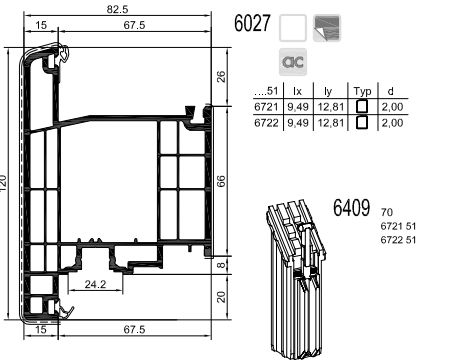
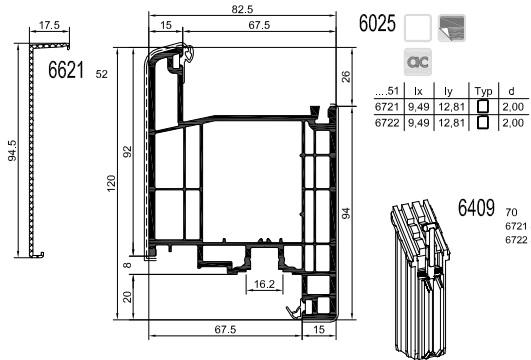

NL plus

NL plus

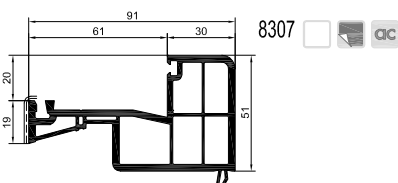
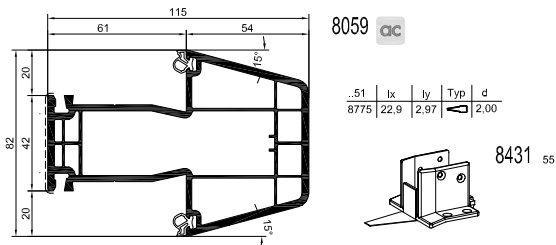
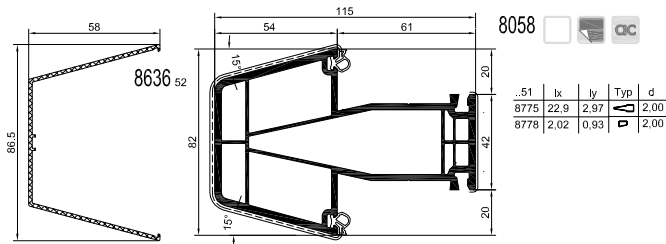
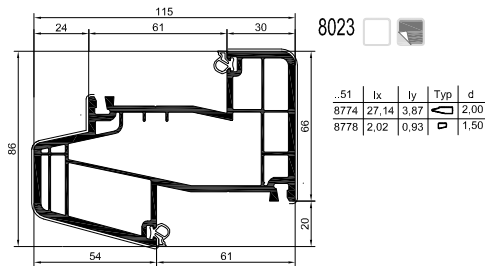
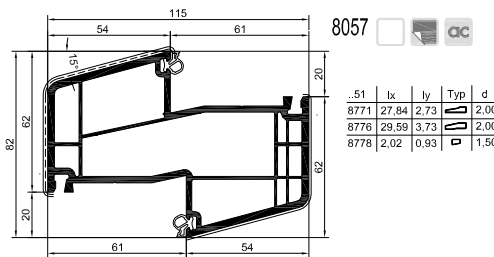
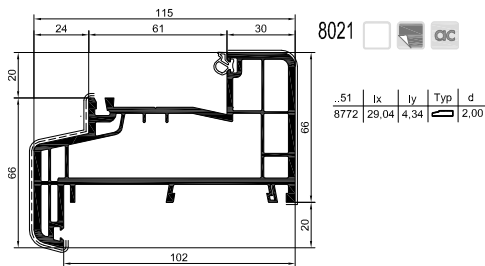
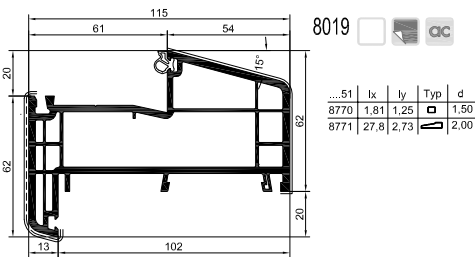
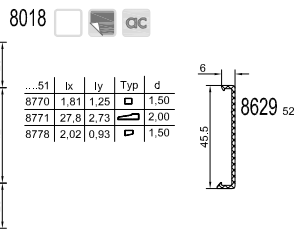
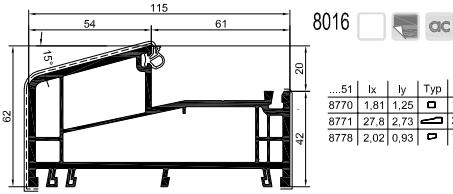

S 3000

S 7000 IQ
S 7000 IQ plus

S 8000 IQ

S 9000

NL plus

Stulp

Sprossen

Glasleisten

Aussteifungen

Dichtungen

Rahmenverbreiterungen

Kopplungsprofile

Eckprofile

Verleistungen

Untere Anschlussprofile

Laibungsverkleidungen

Schwellen

Lüftungssystem

Hebeschiebesysteme

Schiebesysteme

Rollladen / Cassonetto

RAE plus

Klappladen

Sonstiges

NL plus

NL plus

S 3000

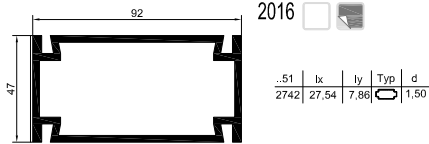

S 7000 IQ
S 7000 IQ plus

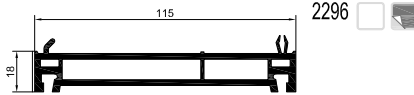

S 8000 IQ

keine Artikel Im GEALAN-Programm

S 9000

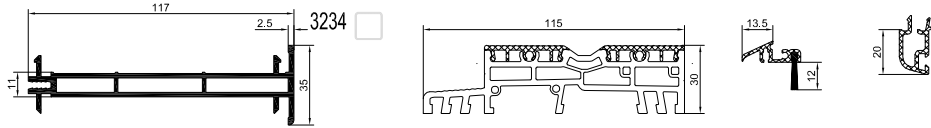

NL plus

Stulp



Sprossen

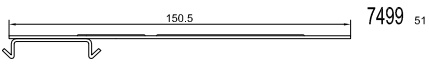

Glasleisten

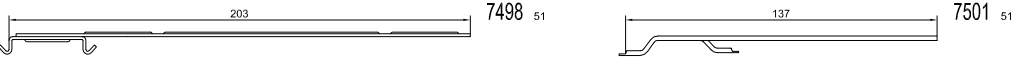

Aussteifungen

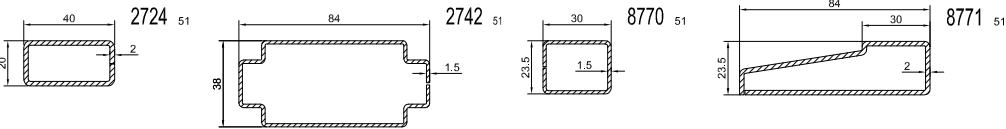

Dichtungen

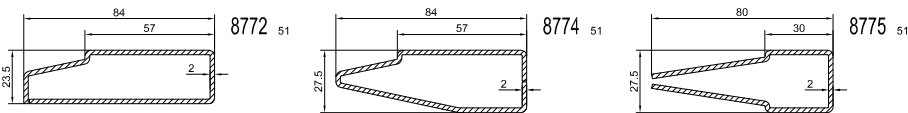

Rahmenverbreiterungen

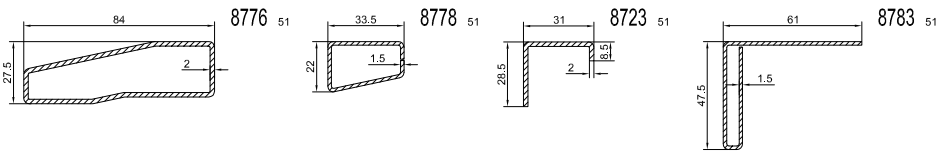

Kopplungsprofile

Eckprofile

Verleistungen

Houtlook

Untere Anschlussprofile

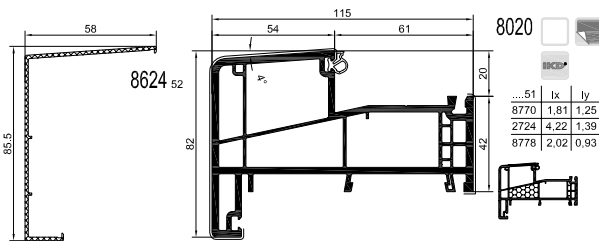

Laibungsverkleidungen

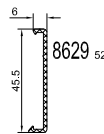

Schwellen

Lüftungssystem

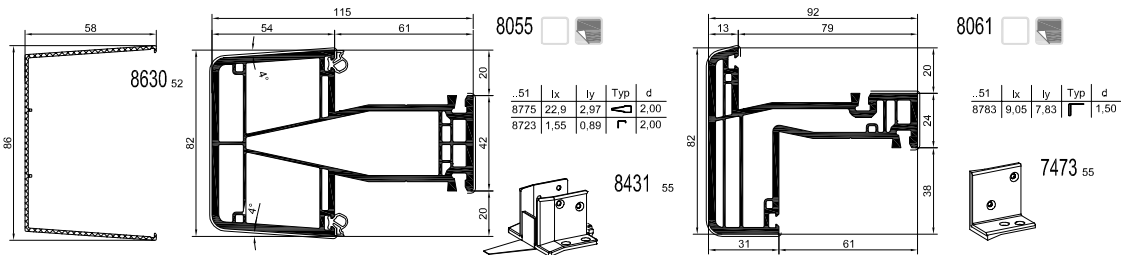

Hebeschiebesysteme

Schiebesysteme

Rollladen / Cassonetto

RAE plus

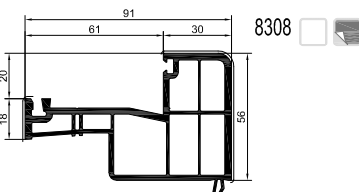

8189 99

8188 92

Klappladen

Sonstiges

Stulp · French Casement

S 3000

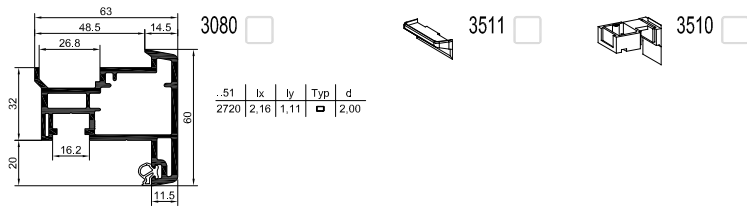

S 7000 IQ

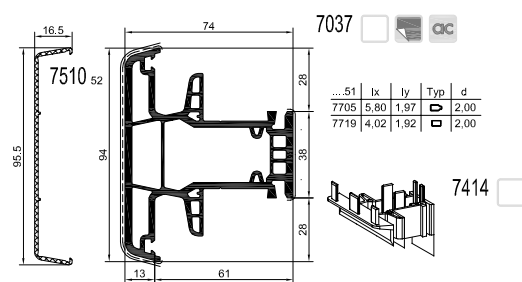
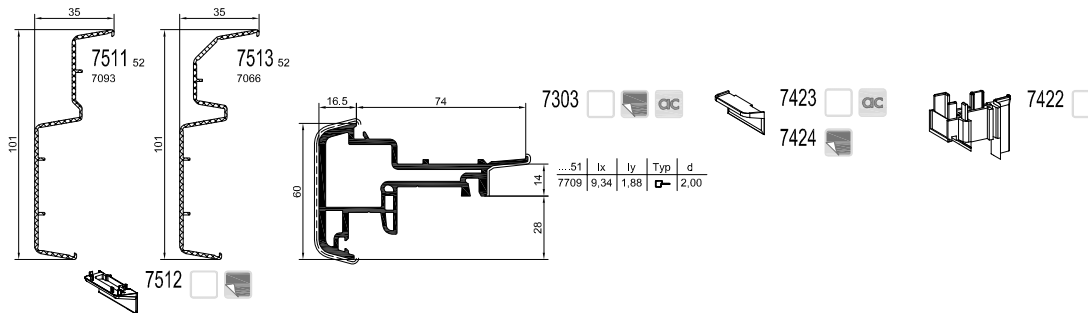
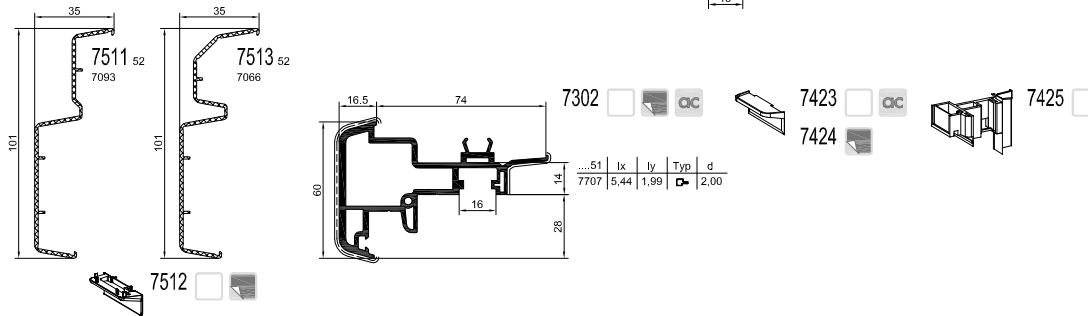
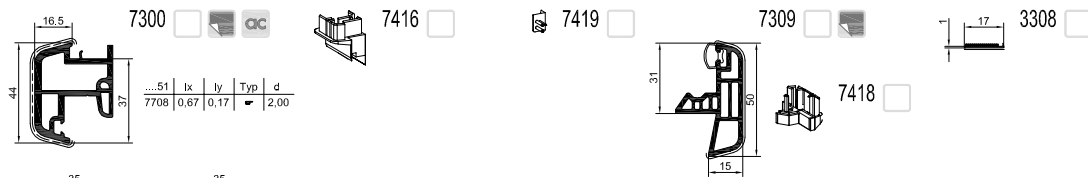

S 7000 IQ Monostulp

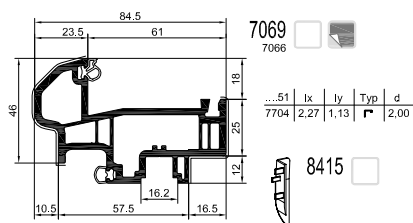

S 3000

S 7000 IQ
S 7000 IQ plus

S 8000 IQ

S 9000

NL plus

Stulp

Sprossen

Glasleisten

Aussteifungen

Dichtungen

Rahmenverbreiterungen

Kopplungsprofile

Eckprofile

Verleistungen

Untere Anschlussprofile

Laibungsverkleidungen

Schwellen

Lüftungssystem

Hebeschiebesysteme

Schiebesysteme

Rollladen / Cassonetto

RAE plus

Klappladen

Sonstiges

Stulp · French Casement

S 3000

S 7000 IQ / S 7000 IQ plus

S 7000 IQ
S 7000 IQ plus

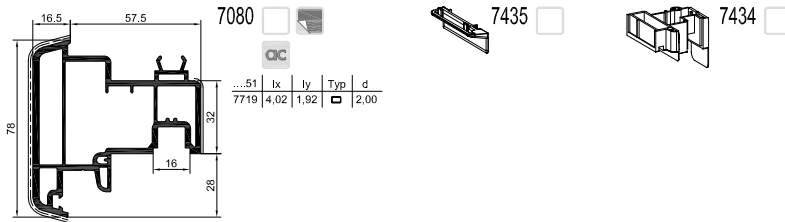

S 8000 IQ

S 9000

NL plus

S 7000 IQ plus

Stulp

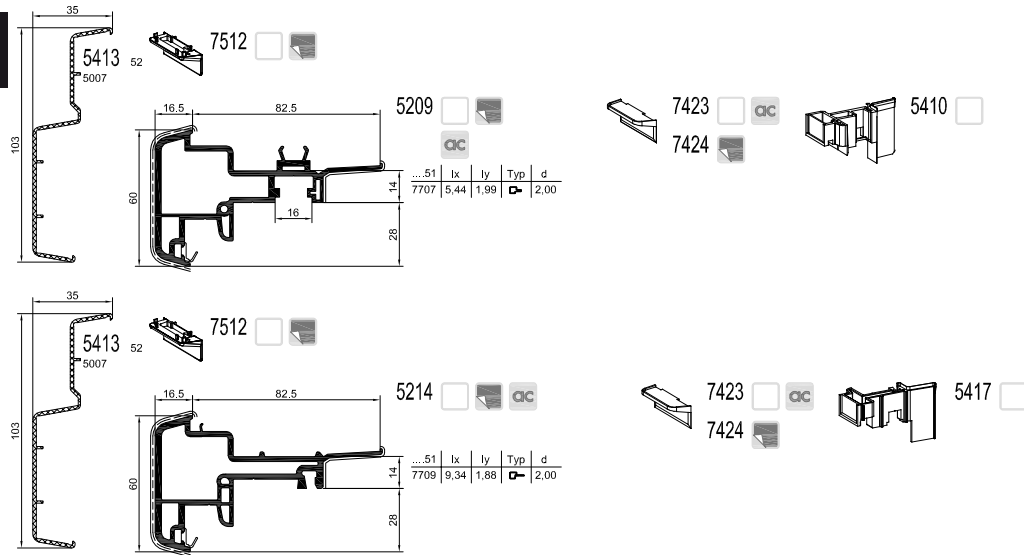

Sprossen

Glasleisten

Aussteifungen

Dichtungen

Rahmenverbreiterungen

Kopplungsprofile

Eckprofile

S 7000 IQ plus Monostulp

Verleistungen

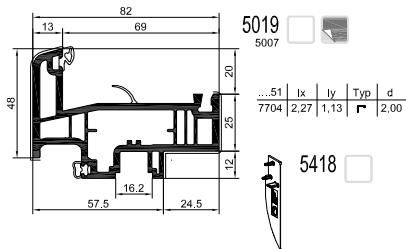

Untere Anschlussprofile

Laibungsverkleidungen

Schwellen

S 8000 IQ

Lüftungssystem

Hebeschiebesysteme



Schiebesysteme

Rollladen / Cassonetto

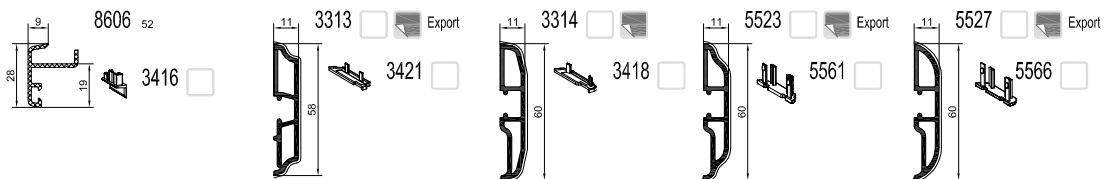

RAE plus

Klappladen

Sonstiges

Stulp · French Casement

S 8000 IQ

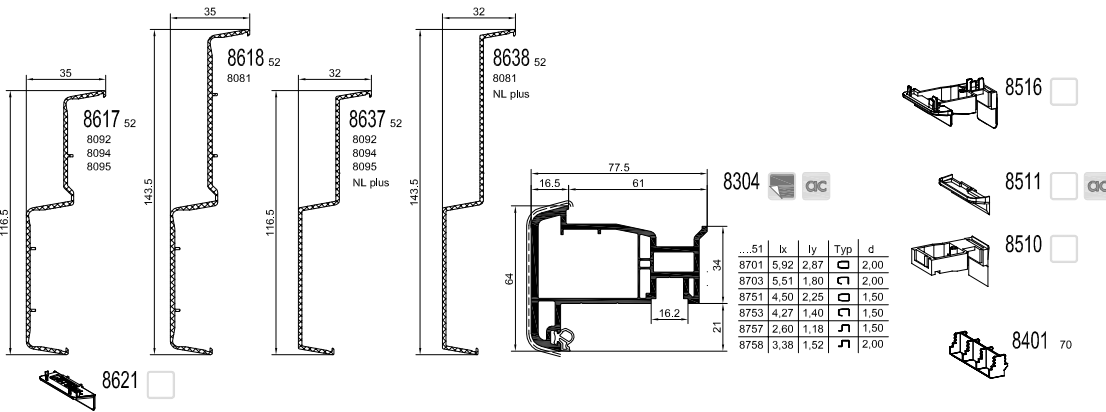
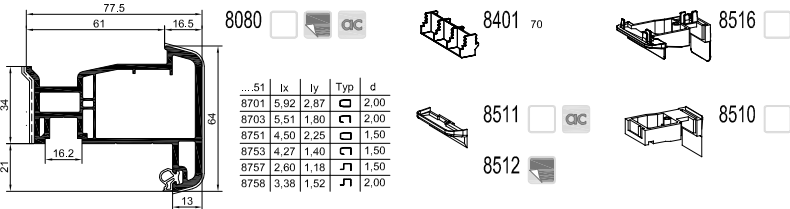
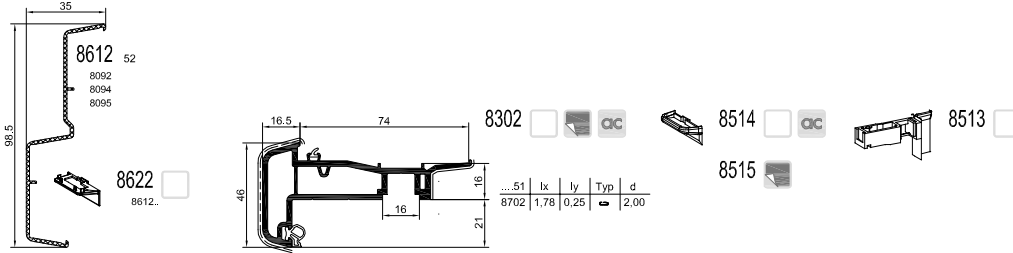

S 8000 IQ Monostulp

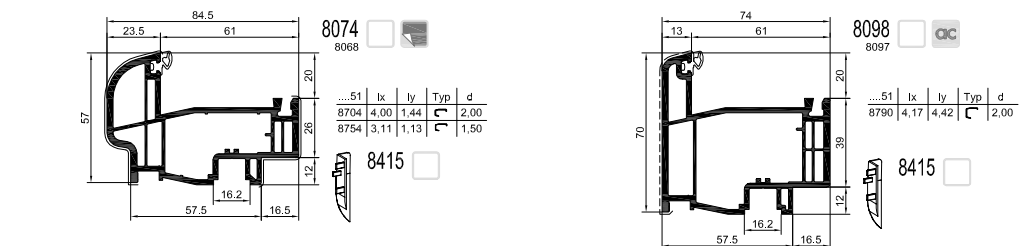
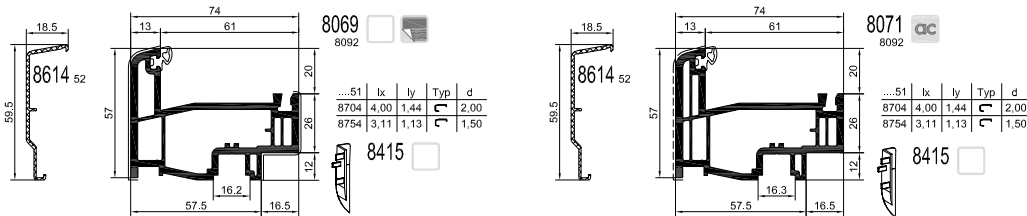
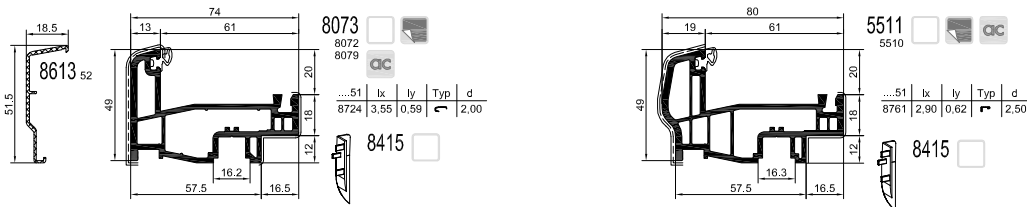

S 3000

S 7000 IQ
S 7000 IQ plus

S 8000 IQ

S 9000

NL plus

Stulp

Sprossen

Glasleisten

Aussteifungen

Dichtungen

Rahmenverbreiterungen

Kopplungsprofile

Eckprofile

Verleistungen

Untere Anschlussprofile

Laibungsverkleidungen

Schwellen

Lüftungssystem

Hebeschiebesysteme

Schiebesysteme

Rollladen / Cassonetto

RAE plus

Klappladen

Sonstiges

Stulp · French Casement

S 3000

S 8000 IQ Monostulp

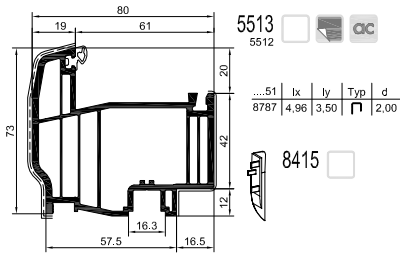

S 7000 IQ
S 7000 IQ plus

S 8000 IQ

S 9000

NL plus

S 9000

Stulp



Sprossen

Glasleisten

Aussteifungen

Dichtungen

Rahmenverbreiterungen

Kopplungsprofile

Eckprofile

Verleistungen

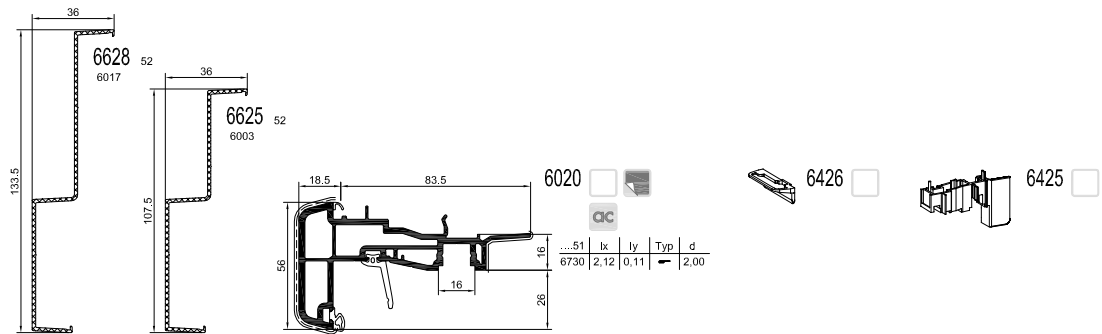

Untere Anschlussprofile

Laibungsverkleidungen

Schwellen

Lüftungssystem

Hebeschiebesysteme

Schiebesysteme

Rollladen / Cassonetto

RAE plus

Klappladen

Sonstiges

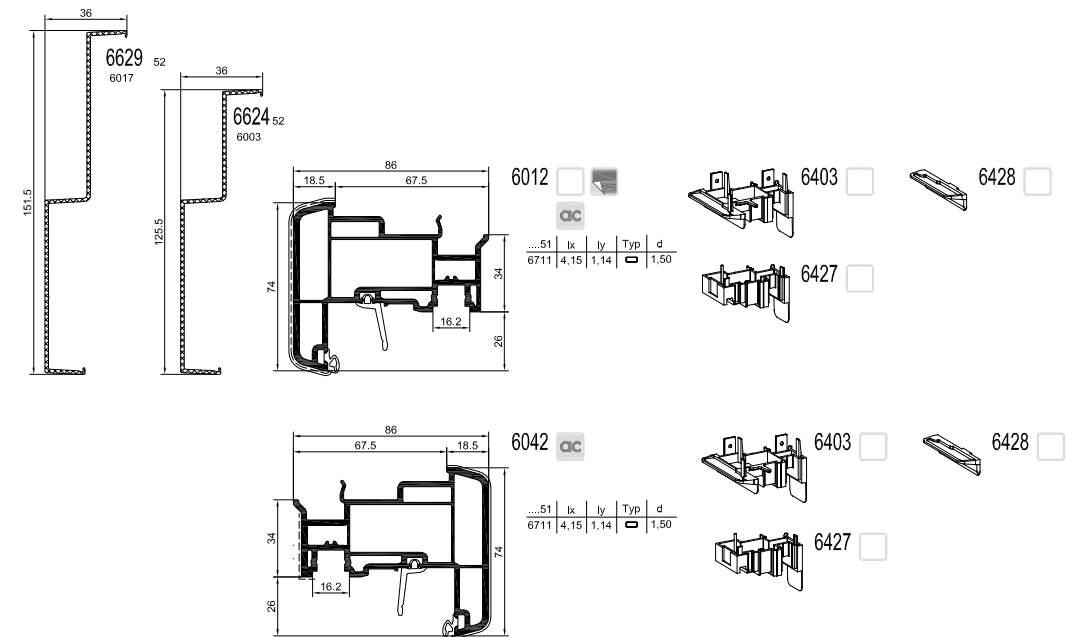

Stulp · French Casement

S 9000 Monostulp

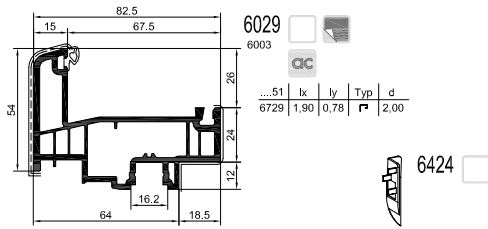

S 3000

S 7000 IQ
S 7000 IQ plus

S 8000 IQ

S 9000

NL plus

Stulp

Sprossen

Glasleisten

Aussteifungen

Dichtungen

Rahmenverbreiterungen

Kopplungsprofile

Eckprofile

Verleistungen

Untere Anschlussprofile

Laibungsverkleidungen

Schwellen

Lüftungssystem

Hebeschiebesysteme

Schiebesysteme

Rollladen / Cassonetto

RAE plus

Klappladen

Sonstiges

Sprossen · Muntins

S 3000

alle Systeme

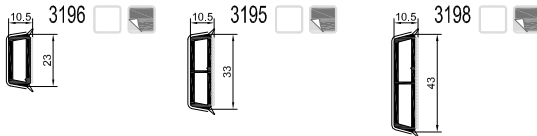

S 7000 IQ
S 7000 IQ plus

S 8000 IQ

S 9000



NL plus

S 7000 IQ

Stulp

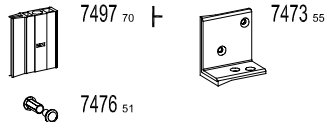
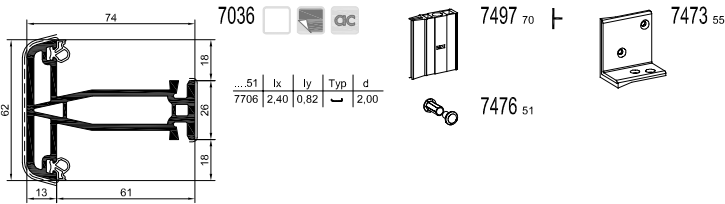

Sprossen

Glasleisten

Aussteifungen

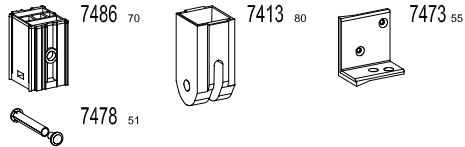
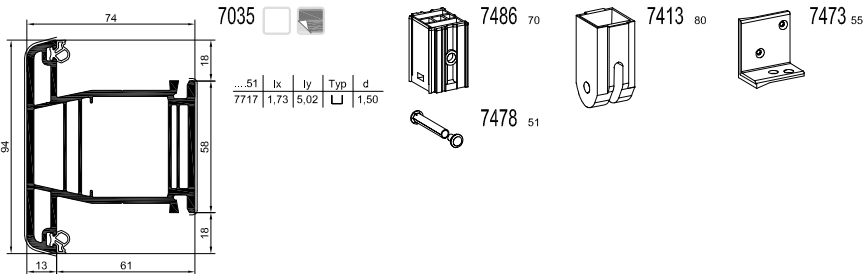

Dichtungen

Rahmenverbreiterungen

Kopplungsprofile

Eckprofile

S 8000 IQ

Verleistungen

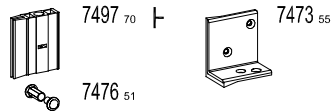
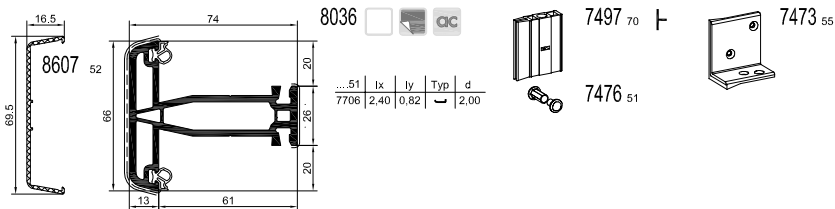

Untere Anschlussprofile

Laibungsverkleidungen

Schwellen

S 7000 IQ plus

Lüftungssystem

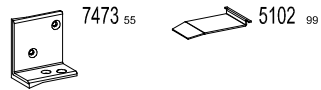
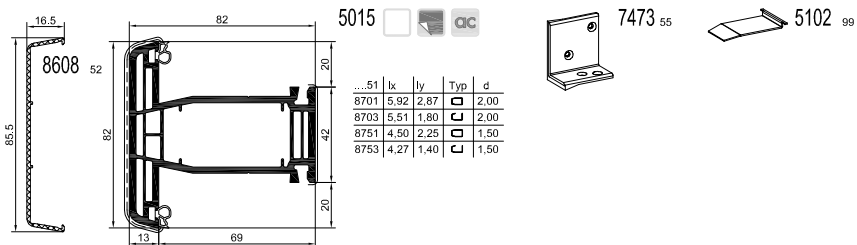

Hebeschiebesysteme

Schiebesysteme

Rollladen / Cassonetto

RAE plus

Klappladen

Sonstiges

Glisleisten · Glazing Beads

S 3000 / SF / ST

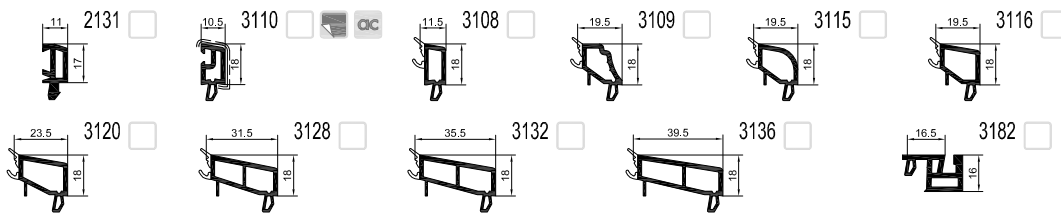

- S 3000
- S 7000 IQ
S 7000 IQ plus
- S 8000 IQ
- S 9000
- NL plus
- Stulp
- Sprossen

S 7000 IQ / S 7000 IQ plus

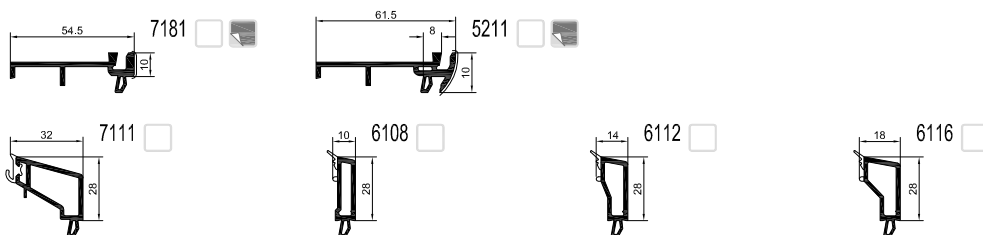

S 7000 IQ / S 8000 IQ / S 7000 IQ plus / NL plus / HST S 8000 IQ / Schiebesysteme 74 mm



S 9000 / HST S 9000



Glisleisten

- Aussteifungen
- Dichtungen
- Rahmenverbreiterungen
- Kopplungsprofile
- Eckprofile
- Verleistungen
- Untere Anschlussprofile
- Laibungsverkleidungen
- Schwellen
- Lüftungssystem
- Hebeschiebesysteme
- Schiebesysteme
- Rollladen / Cassonetto
- RAE plus
- Klappladen
- Sonstiges

Aussteifungen · Reinforcements

alle Systeme

S 3000

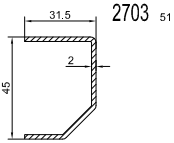

2703 51

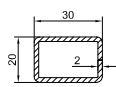

2720 51

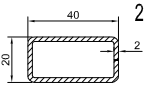

2724 51

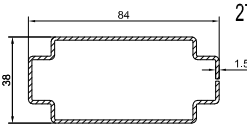

2742 51

S 7000 IQ
S 7000 IQ plus

S 8000 IQ

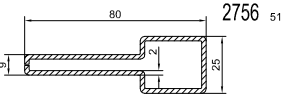

2756 51

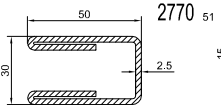

2770 51

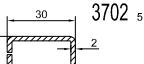

3702 51

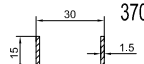

3704 51

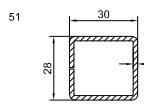

3710 51

S 9000

NL plus

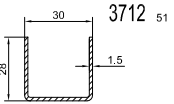

3712 51

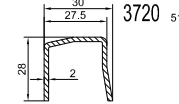

3720 51

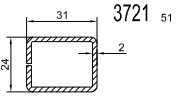

3721 51

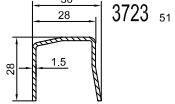

3723 51

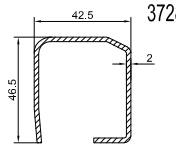

3728 51

Stulp

Sprossen

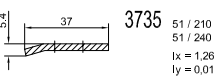

3735 51 / 210
51 / 240
ix = 1,26
iy = -0,01

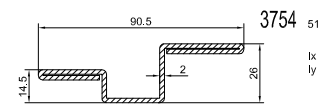

3754 51

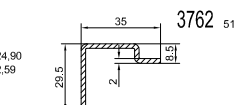

3762 51

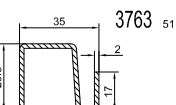

3763 51

Glasleisten

Aussteifungen

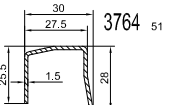

3764 51

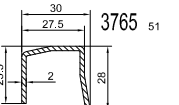

3765 51

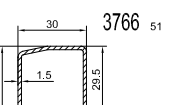

3766 51

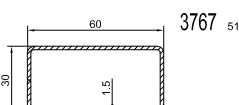

3767 51

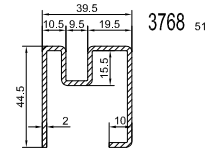

3768 51

Dichtungen

Rahmenverbreiterungen

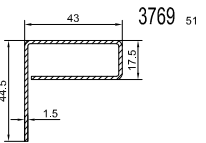

3769 51

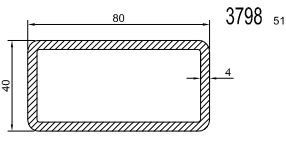

3798 51

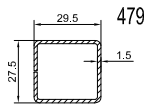

4794 51

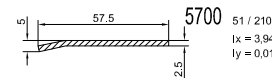

5700 51 / 210
ix = 3,94
iy = 0,01

Kopplungsprofile

Eckprofile

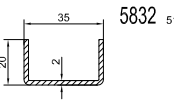

5832 51

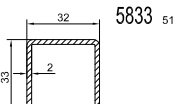

5833 51

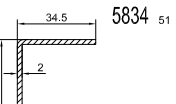

5834 51

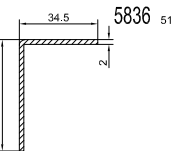

5836 51

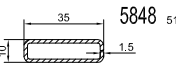

5848 51

Verleistungen

Untere Anschlussprofile

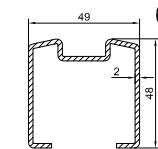

6340 51

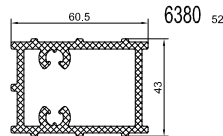

6380 52

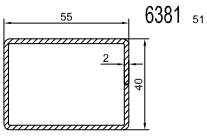

6381 51

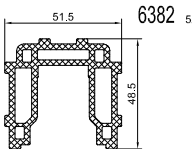

6382 52

Laibungsverkleidungen

Schwellen

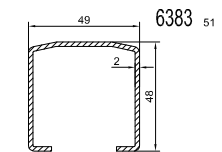

6383 51

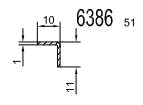

6386 51

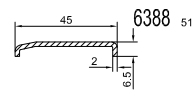

6388 51

Lüftungssystem

Hebeschiebesysteme

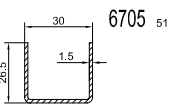

6705 51

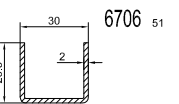

6706 51

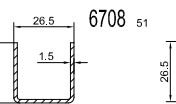

6708 51

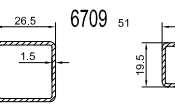

6709 51

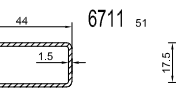

6711 51

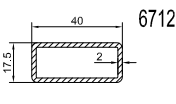

6712 51

Schiebesysteme

Rollladen / Cassonetto

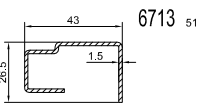

6713 51

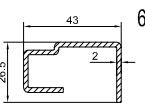

6714 51

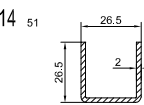

6715 51

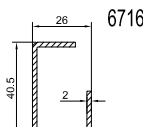

6716 51

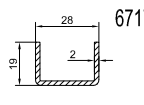

6717 51

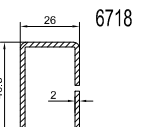

6718 51

RAE plus

Klappladen

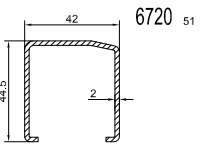

6720 51

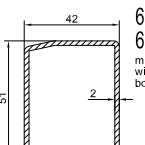

6721 51

6722 51 L / R
mit Schließkastenausfräsung
with milled out lock position
boîtier de serrure (par fraisage)

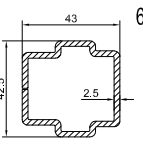

6725 51

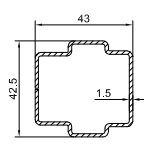

6726 51

Sonstiges

Aussteifungen · Reinforcements

alle Systeme

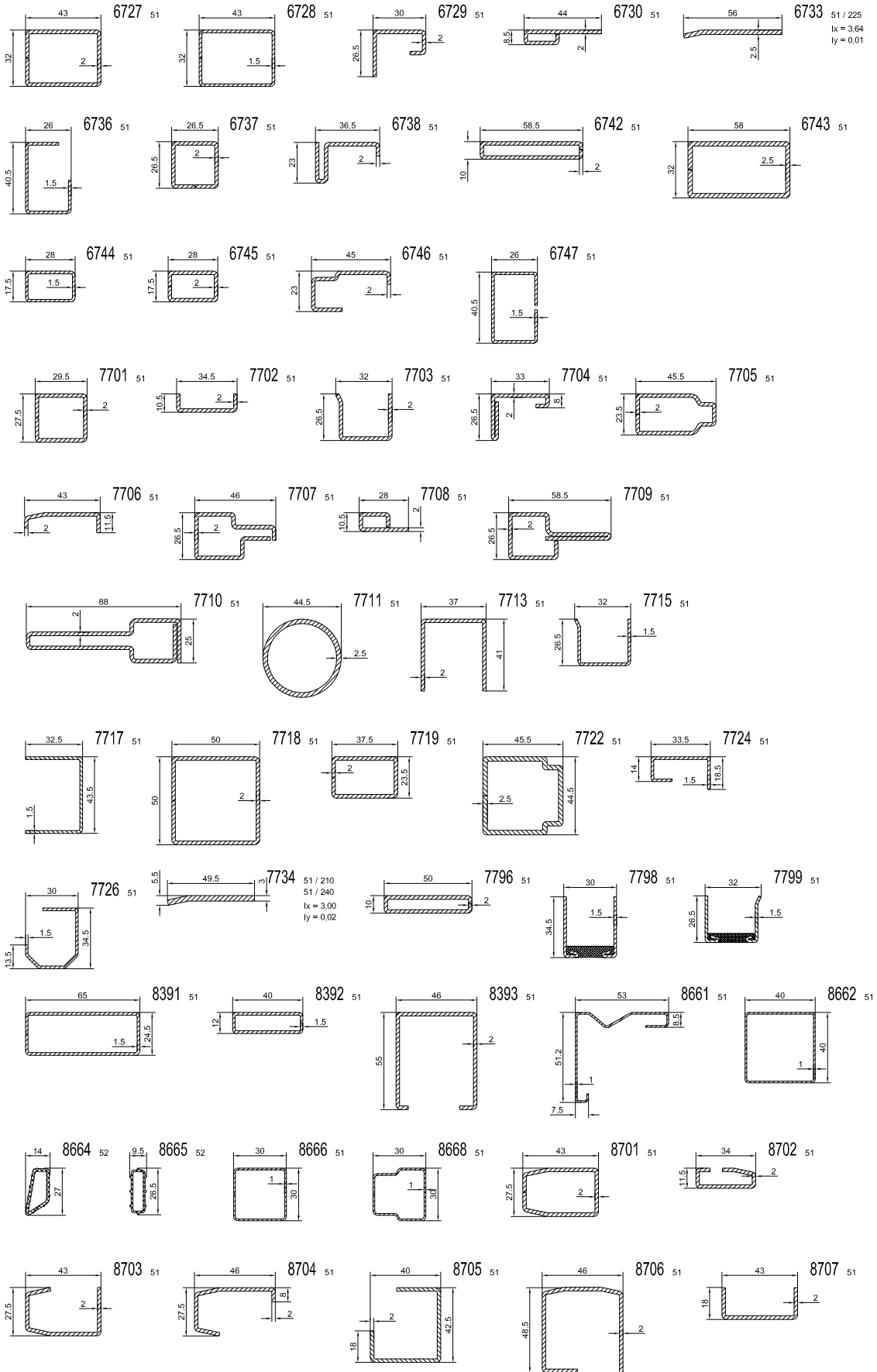

S 3000

S 7000 IQ
S 7000 IQ plus

S 8000 IQ

S 9000

NL plus

Stulp

Sprossen

Glasleisten

Aussteifungen

Dichtungen

Rahmenverbreiterungen

Kopplungsprofile

Eckprofile

Verleistungen

Untere Anschlussprofile

Laibungsverkleidungen

Schwellen

Lüftungssystem

Hebeschiebesysteme

Schiebesysteme

Rolläden / Cassonetto

RAE plus

Klappläden

Sonstiges

Aussteifungen · Reinforcements

alle Systeme

S 3000

S 7000 IQ
S 7000 IQ plus

S 8000 IQ

S 9000

NL plus

Stulp

Sprossen

Glasleisten

Aussteifungen

Dichtungen

Rahmenverbreiterungen

Kopplungsprofile

Eckprofile

Verleistungen

Untere Anschlussprofile

Laibungsverkleidungen

Schwellen

Lüftungssystem

Hebeschiebesysteme

Schiebesysteme

Rollladen / Cassonetto

RAE plus

Klappladen

Sonstiges

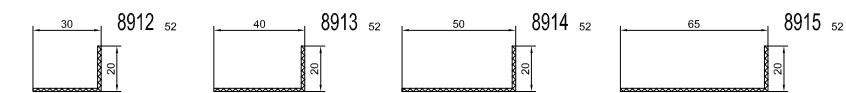
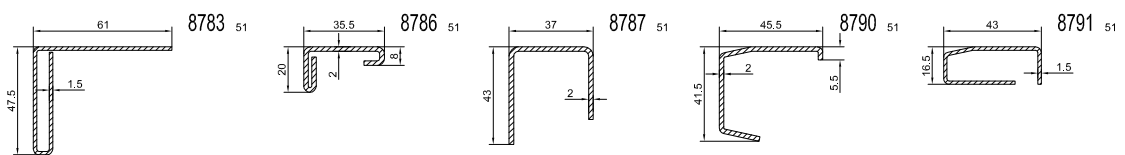
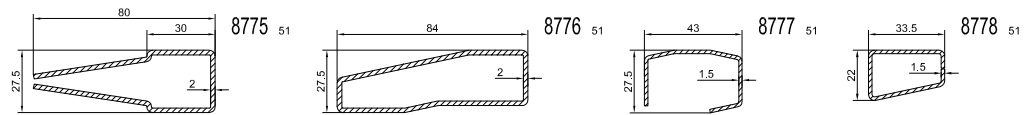
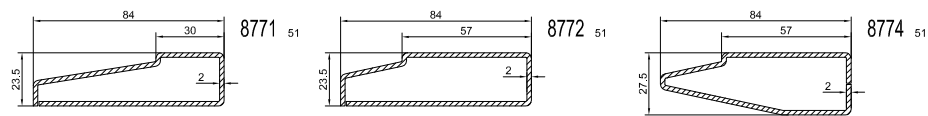
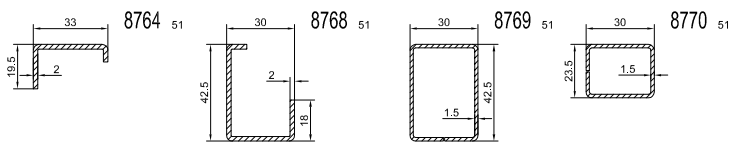
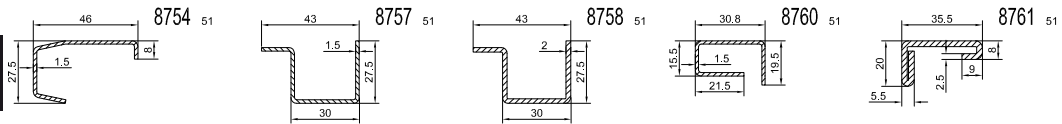
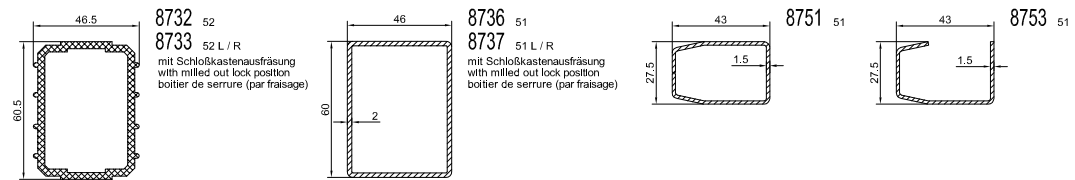
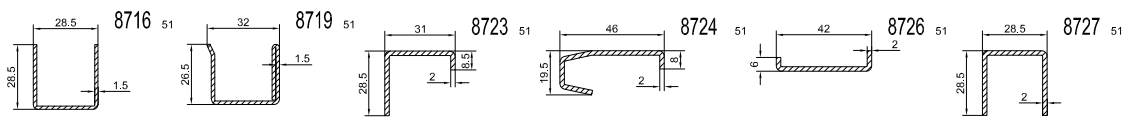
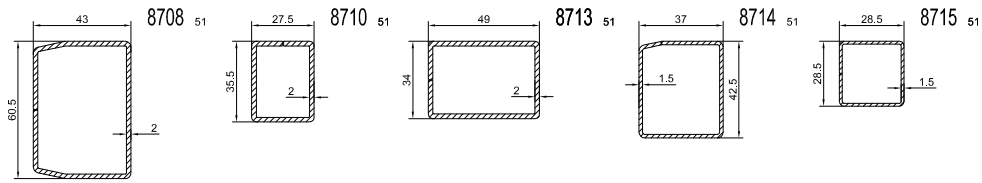

Dichtungen · Gaskets

Glasdichtung · Glazing Gaskets

S 2000

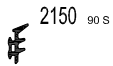

2150 90 S

S 3000

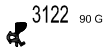

3122 90 G



3123 90 G



3152 90 S/G ST

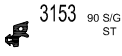

3153 90 S/G ST

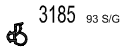

3185 93 S/G

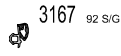

3167 92 S/G

S 7000 IQ / S 7000 IQ plus

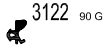

3122 90 G



3123 90 G

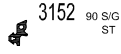

3152 90 S/G ST

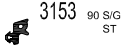

3153 90 S/G ST

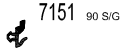

7151 90 S/G

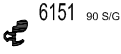

6151 90 S/G

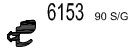

6153 90 S/G

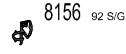

8156 92 S/G

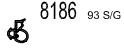

8186 93 S/G

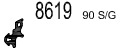

8619 90 S/G

S 8000 IQ

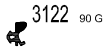

3122 90 G



3123 90 G



3152 90 S/G ST

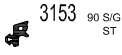

3153 90 S/G ST

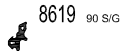

8619 90 S/G

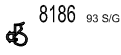

8186 93 S/G

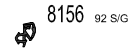

8156 92 S/G

S 9000

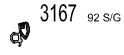

3167 92 S/G

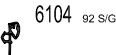

6104 92 S/G



6151 90 S/G

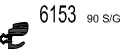

6153 90 S/G

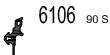

6106 90 S

Anschlagdichtung · Rebate Seal

S 2000

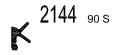

2144 90 S

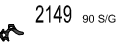

2149 90 S/G

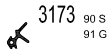

3173 90 S 91 G

S 3000

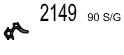

2149 90 S/G



3173 90 S 91 G



3184 90 S/G

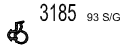

3185 93 S/G

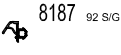

8187 92 S/G

S 7000 IQ / S 7000 IQ plus

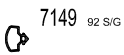

7149 92 S/G

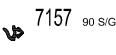

7157 90 S/G

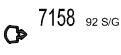

7158 92 S/G

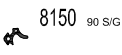

8150 90 S/G

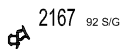

2167 92 S/G

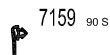

7159 90 S

S 8000 IQ

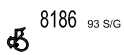

8186 93 S/G

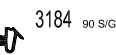

3184 90 S/G

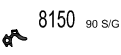

8150 90 S/G

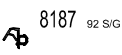

8187 92 S/G

S 9000

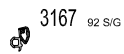

3167 92 S/G

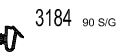

3184 90 S/G

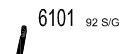

6101 92 S/G

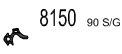

8150 90 S/G

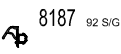

8187 92 S/G

Haustür · Front Door

S 3000

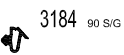

3184 90 S/G



3173 90 S 91 G

S 8000 IQ

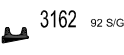

3162 92 S/G

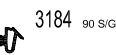

3184 90 S/G

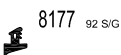

8177 92 S/G



8178 90

S 3000

S 7000 IQ
S 7000 IQ plus

S 8000 IQ

S 9000

NL plus

Stulp

Sprossen

Glasleisten

Aussteifungen

Dichtungen

Rahmenverbreiterungen

Kopplungsprofile

Eckprofile

Verleistungen

Untere Anschlussprofile

Laibungsverkleidungen

Schwellen

Lüftungssystem

Hebeschiebesysteme

Schiebesysteme

Rollladen / Cassonetto

RAE plus

Klappläden

Sonstiges

Dichtungen · Gaskets Haustür · Front Door

S 3000

S 9000



S 7000 IQ
S 7000 IQ plus

S 8000 IQ

Faltdür · Folding Door

S 8000 IQ / S 9000

S 9000

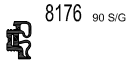

NL plus

Bürstendichtungen · Brush Seals

Bürstendichtungen

Stulp

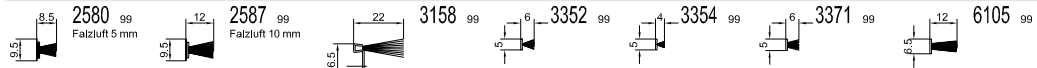

Sprossen

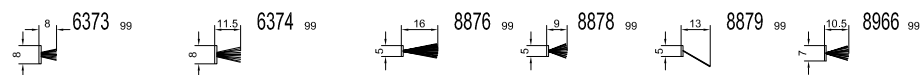

Glasleisten

Dichtungen · Gaskets

Dichtungen

Dichtungen

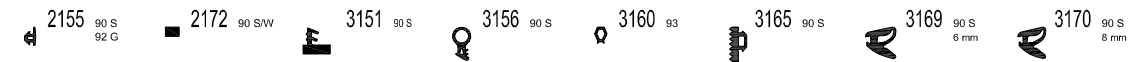

Rahmenverbreiterungen

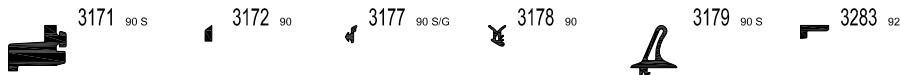

Kopplungsprofile



Eckprofile



Verleistungen

Klebeband · Tape

STV®



Untere Anschlussprofile

Laibungsverkleidungen

Schwellen

Lüftungssystem

Hebeschiebesysteme

Schiebesysteme

Rollladen / Cassonetto

RAE plus

Klappladen

Sonstiges

Rahmenverbreiterungen · Frame Extensions

S 3000

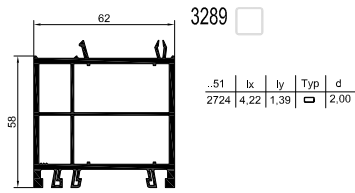
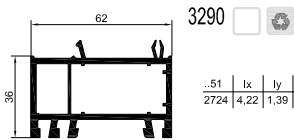

S 3000

S 7000 IQ
S 7000 IQ plus

S 8000 IQ

S 9000

NL plus

Stulp

Sprossen

Glasleisten

Aussteifungen

Dichtungen

S 7000 IQ / S 8000 IQ / 3-Kammer

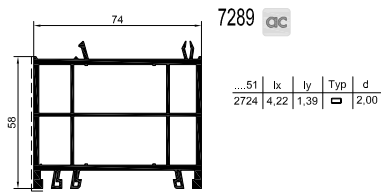
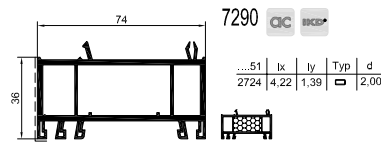
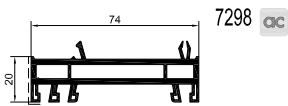

S 7000 IQ / S 8000 IQ / 5-Kammer

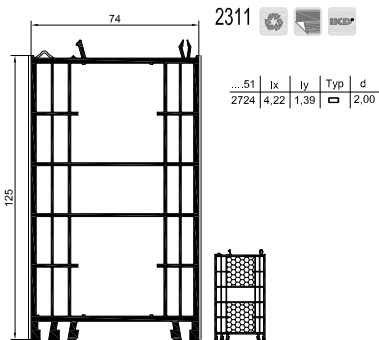
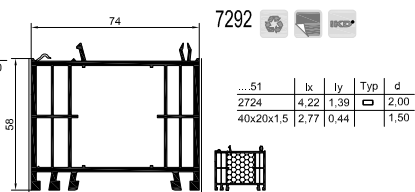
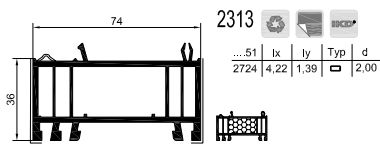
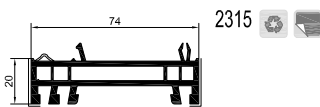

S 7000 IQ plus / S 9000

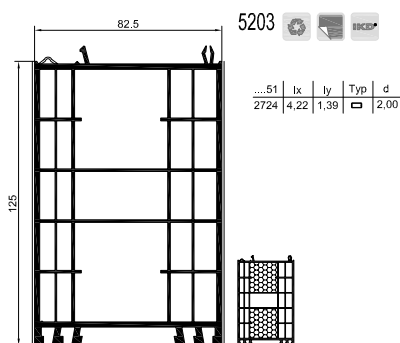
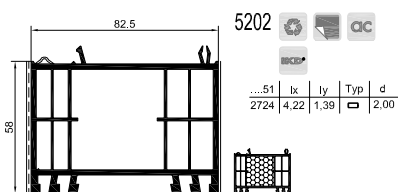
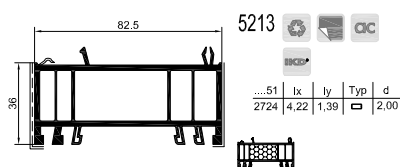
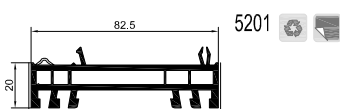

Rahmenverbreiterungen

Kopplungsprofile

Eckprofile

Verleistungen

Untere Anschlussprofile

Laibungsverkleidungen

Schwellen

Lüftungssystem

Hebeschiebesysteme

Schiebesysteme

Rollladen / Cassonetto

RAE plus

Klappladen

Sonstiges

Kopplungsprofile · Coupling Profiles

S 3000

System unabhängig

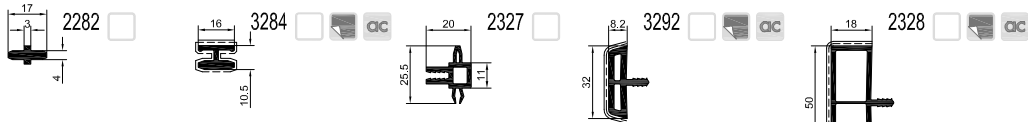

S 7000 IQ
S 7000 IQ plus

S 8000 IQ

S 9000

NL plus

Stulp

Sprossen

Glasleisten

Aussteifungen

Dichtungen

Rahmenverbreiterungen

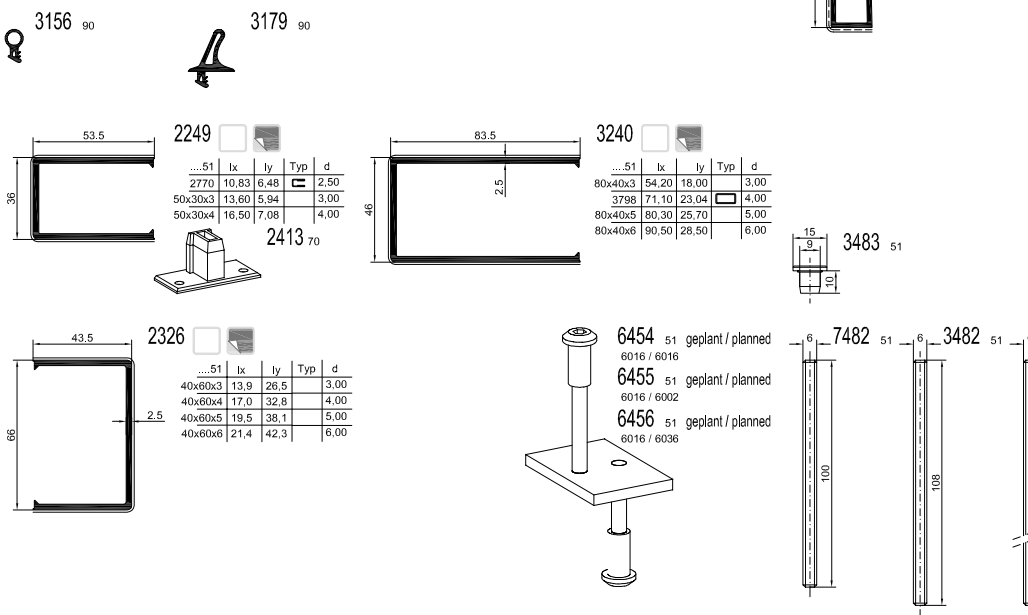

S 7000 IQ / S 8000 IQ

Kopplungsprofile

Eckprofile

Verleistungen

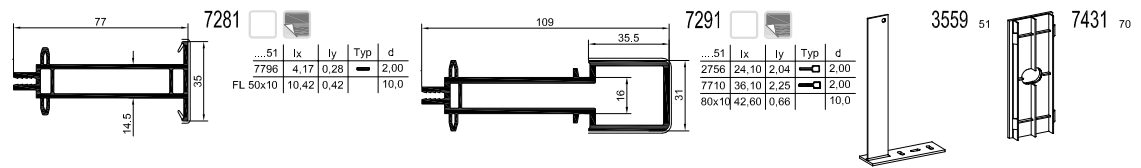

S 8000 IQ / NL plus Brüstungsverglasung

Untere Anschlussprofile

Laibungsverkleidungen

Schwellen

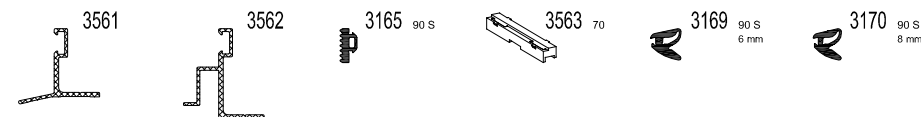

Lüftungssystem

Hebeschiebesysteme

Schiebesysteme

Rollladen / Cassonetto

RAE plus

Klappladen

Sonstiges

S 7000 IQ plus / S 9000

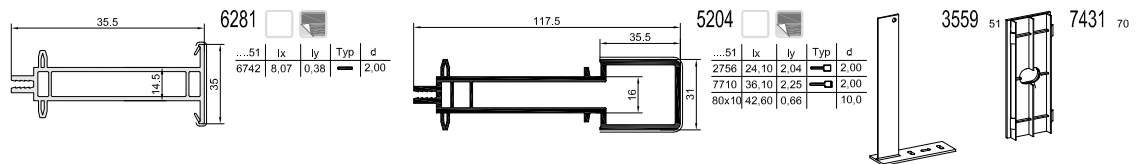

Eckprofile · Corner Profiles

S 7000 IQ / S 8000 IQ

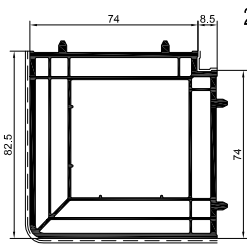

2304

...51	lx	ly	Typ	d
7718	14,37	14,37		2,00
50x50x4	25,00	25,00		4,00
50x50x5	28,90	28,90		5,00

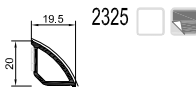

2325

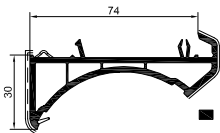

2234

2172 90 SW

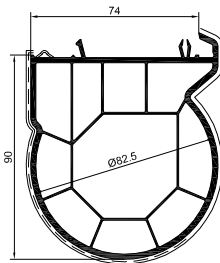

2233

...51	lx	ly	Typ	d
2703	1,91	5,93		2,00
7711	7,54	7,54		2,60

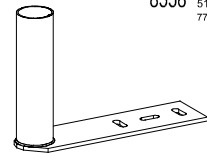

8558 ⁵¹₇₇₁₁

S 7000 IQ plus / S 9000

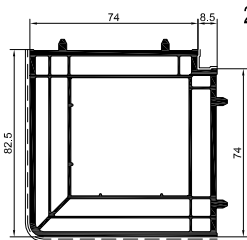

2304

...51	lx	ly	Typ	d
7718	14,37	14,37		2,00
50x50x4	25,00	25,00		4,00
50x50x5	28,90	28,90		5,00

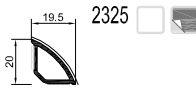

2325

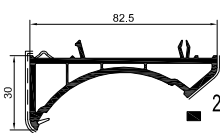

5207

2172 90 SW

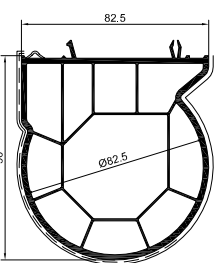

5206

...51	lx	ly	Typ	d
2703	1,91	5,93		2,00
7711	7,54	7,54		2,60

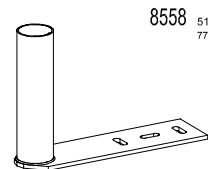

8558 ⁵¹₇₇₁₁

S 3000

S 7000 IQ
S 7000 IQ plus

S 8000 IQ

S 9000

NL plus

Stulp

Sprossen

Glasleisten

Aussteifungen

Dichtungen

Rahmenverbreiterungen

Kopplungsprofile

Eckprofile

Verleistungen

Untere Anschlussprofile

Laibungsverkleidungen

Schwellen

Lüftungssystem

Hebeschiebesysteme

Schiebesysteme

Rollladen / Cassonetto

RAE plus

Klappladen

Sonstiges

Verleistungen · Casing Profiles

System unabhängig

S 3000

S 7000 IQ
S 7000 IQ plus

S 8000 IQ

S 9000

NL plus

Stulp

Sprossen

Glasleisten

Aussteifungen

Dichtungen

Rahmenverbreiterungen

Kopplungsprofile

Eckprofile

Verleistungen

Untere Anschlussprofile

Laibungsverkleidungen

Schwellen

Lüftungssystem

Hebeschiebesysteme

Schiebesysteme

Rollladen / Cassonetto

RAE plus

Klappladen

Sonstiges

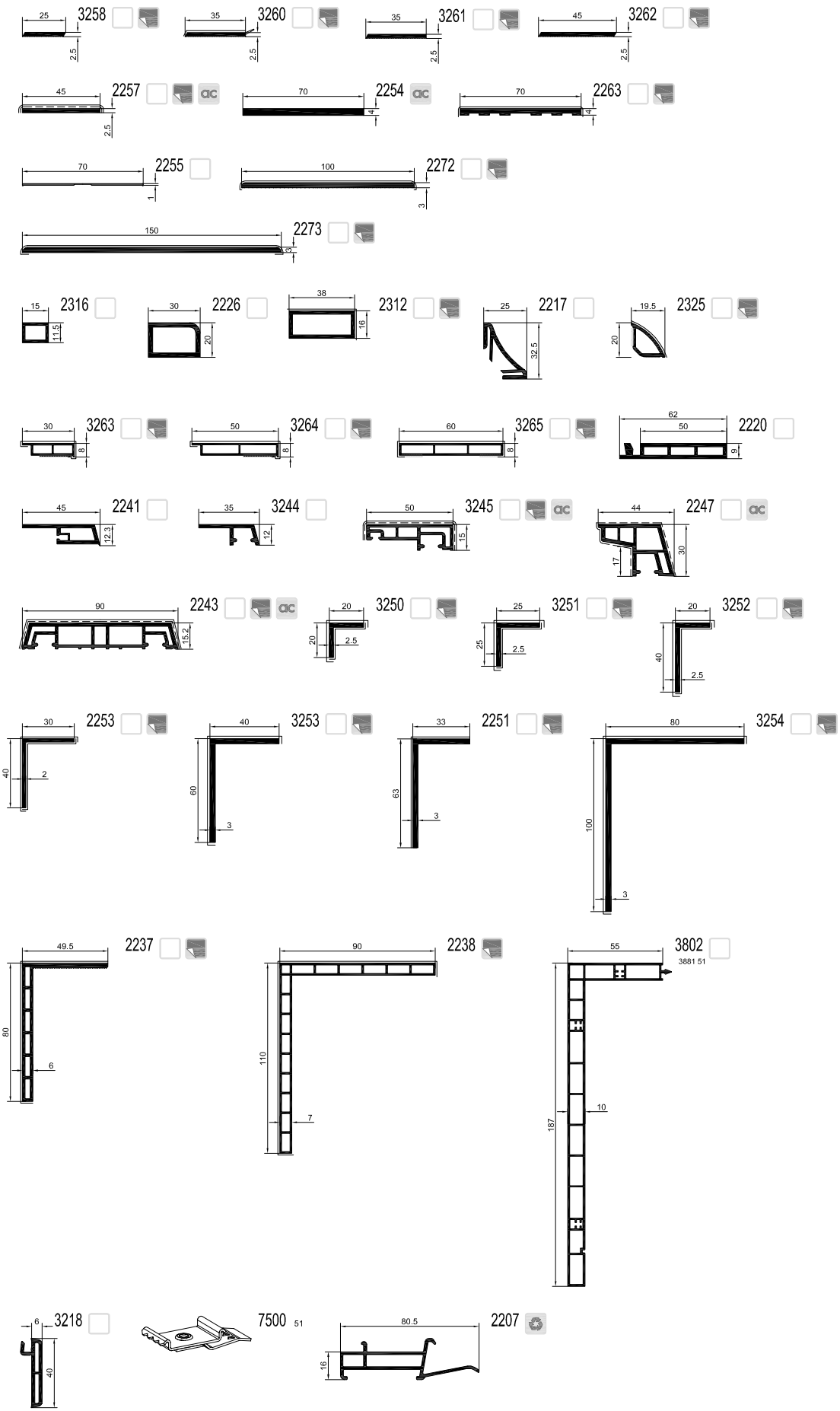

Untere Anschlussprofile · Sill Profiles

System unabhängig

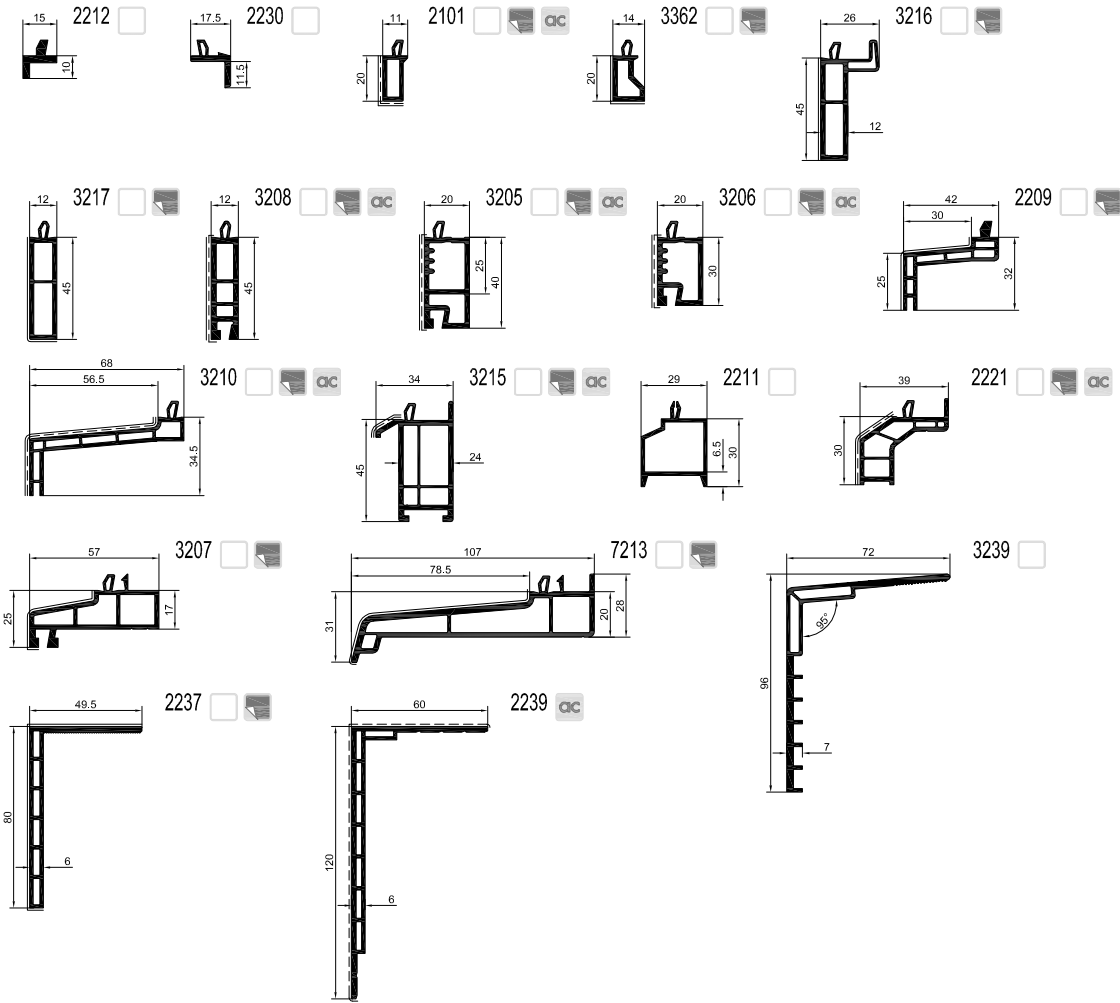

S 3000

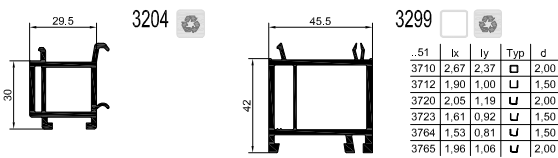

S 7000 IQ / S 8000 IQ

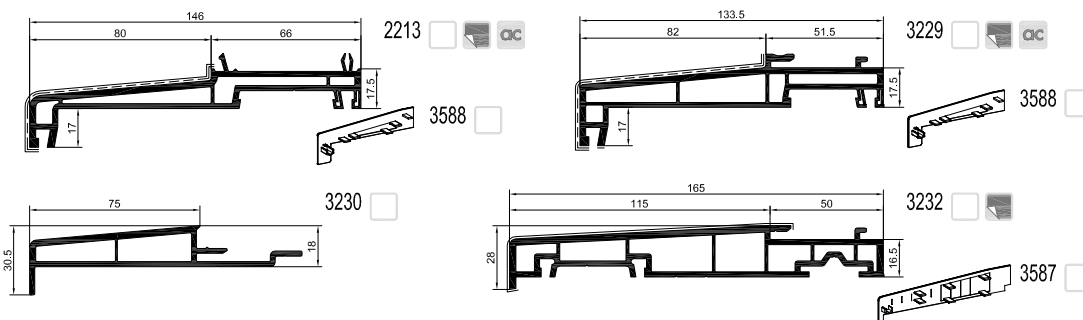

S 3000

S 7000 IQ
S 7000 IQ plus

S 8000 IQ

S 9000

NL plus

Stulp

Sprossen

Glasleisten

Aussteifungen

Dichtungen

Rahmenverbreiterungen

Kopplungsprofile

Eckprofile

Verleistungen

Untere Anschlussprofile

Laibungsverkleidungen

Schwellen

Lüftungssystem

Hebeschiebesysteme

Schiebesysteme

Rollladen / Cassonetto

RAE plus

Klappladen

Sonstiges

Untere Anschlussprofile · Sill Profiles

S 3000

S 8000 IQ

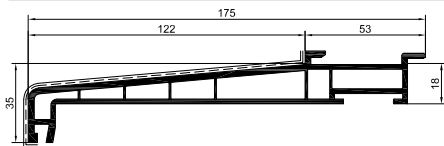

2219

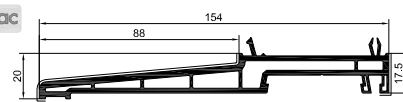

2203



S 7000 IQ
S 7000 IQ plus

S 8000 IQ

S 9000

S 7000 IQ / S 8000 IQ / S 7000 IQ plus / S 9000

NL plus

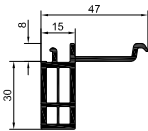

7201

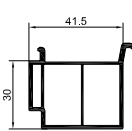

7202

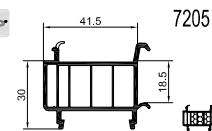

7205

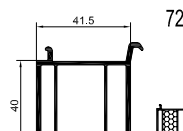

7206



Stulp

Sprossen

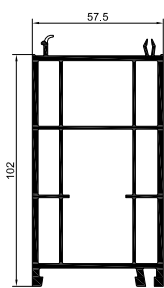

7288



...51	ix	ly	Typ	d
3710	2.67	2.37	□	2.00
3712	1.90	1.00	□	1.50
4794	1.98	1.78	□	1.50
7701	2.51	2.26	□	2.00

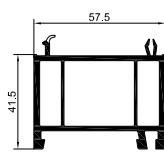

7299



...51	ix	ly	Typ	d
3710	2.67	2.37	□	2.00
3712	1.90	1.00	□	1.50
4794	1.98	1.78	□	1.50
7701	2.51	2.26	□	2.00

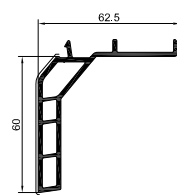

7209



Glasleisten

Aussteifungen

Dichtungen

Rahmenverbreiterungen

Kopplungsprofile

S 7000 IQ plus / S 9000

Eckprofile

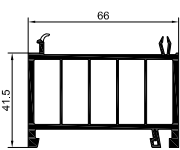

5205



Verleistungen

Untere Anschlussprofile

Laibungsverkleidungen

Schwellen

Lüftungssystem

Hebeschiebesysteme

Schiebesysteme

Rollladen / Cassonetto

RAE plus

Klappladen

Sonstiges

Laibungsverkleidungen · Casing

System unabhängig

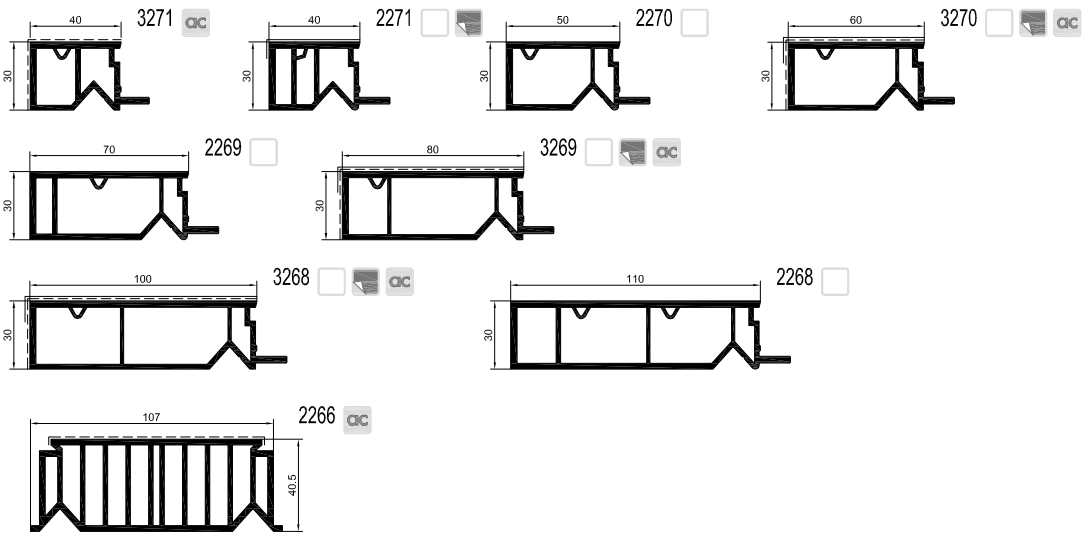

S 3000

S 7000 IQ
S 7000 IQ plus

S 8000 IQ

S 9000

NL plus

Stulp

Sprossen

Glasleisten

Aussteifungen

Dichtungen

Rahmenverbreiterungen

Kopplungsprofile

Eckprofile

Verleistungen

Untere Anschlussprofile

Laibungsverkleidungen

Schwellen

Lüftungssystem

Hebeschiebesysteme

Schiebesysteme

Rollladen / Cassonetto

RAE plus

Klappladen

Sonstiges

Schwellen · Thresholds

S 3000

System unabhängig

S 7000 IQ
S 7000 IQ plus

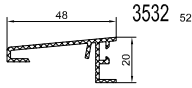

S 8000 IQ

S 7000 IQ

S 9000

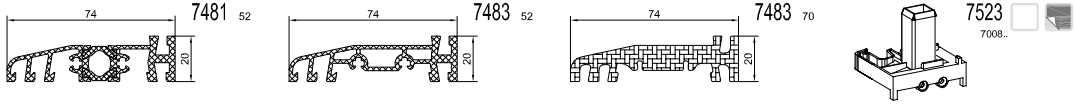

NL plus

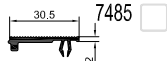

Stulp

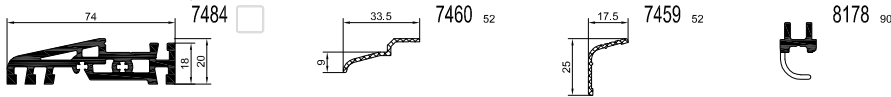

Sprossen

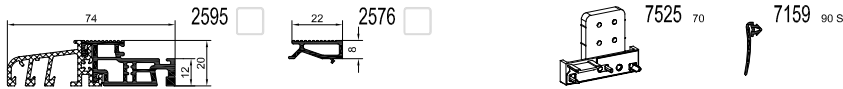

Glasleisten

Aussteifungen



Dichtungen

S 8000 IQ

Rahmenverbreiterungen

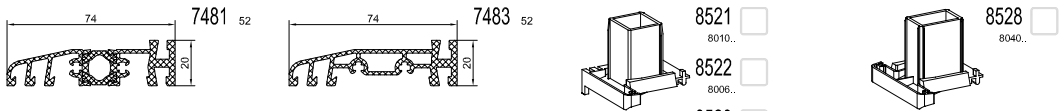

Kopplungsprofile

Eckprofile



Verleistungen

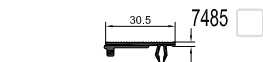

Untere Anschlussprofile

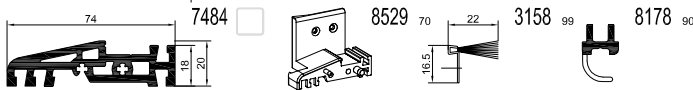

Laibungsverkleidungen

Schwellen

Lüftungssystem

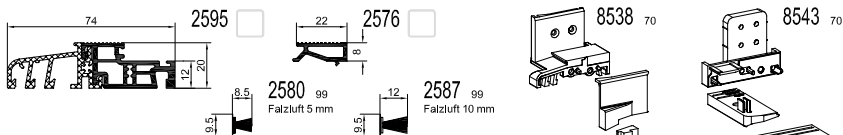

Hebeschiebesysteme

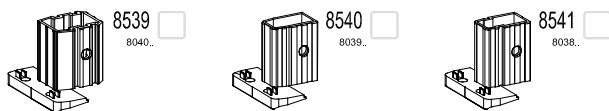

Schiebesysteme

Rollladen / Cassonetto

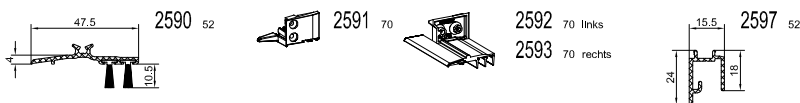

RAE plus

Klappladen

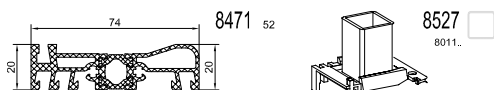

Sonstiges

Schwellen · Thresholds

S 8000 IQ

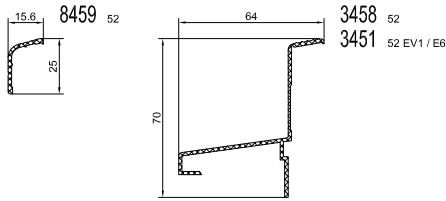

S 7000 IQ plus

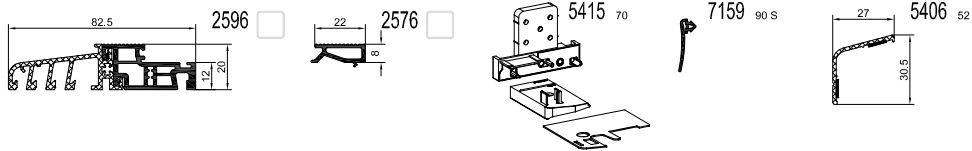

S 9000

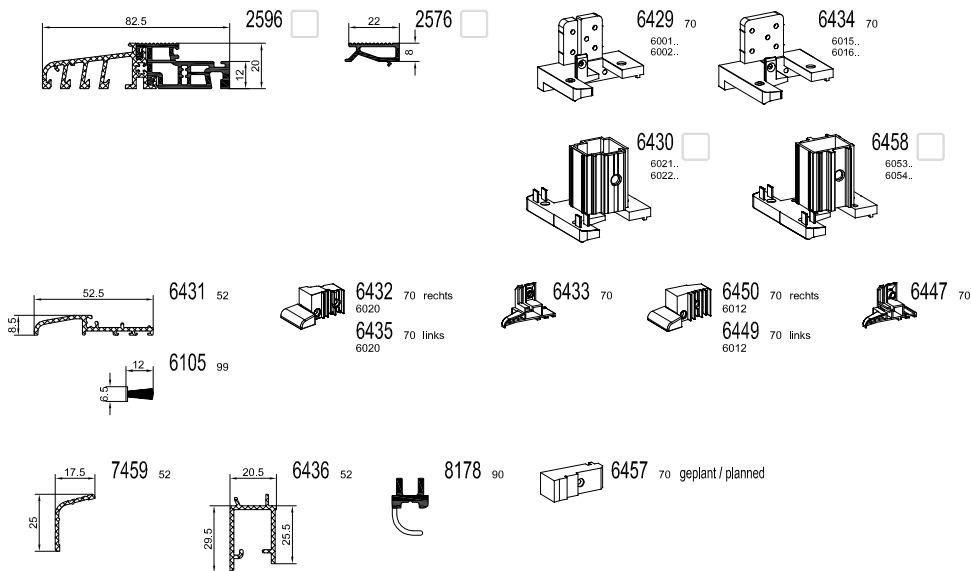

S 3000

S 7000 IQ
S 7000 IQ plus

S 8000 IQ

S 9000

NL plus

Stulp

Sprossen

Glasleisten

Aussteifungen

Dichtungen

Rahmenverbreiterungen

Kopplungsprofile

Eckprofile

Verleistungen

Untere Anschlussprofile

Laibungsverkleidungen

Schwellen

Lüftungssystem

Hebeschiebesysteme

Schiebesysteme

Rollladen / Cassonetto

RAE plus

Klappladen

Sonstiges

Lüftungssystem · Ventilation System

S 3000

GECCO 2

S 7000 IQ
S 7000 IQ plus

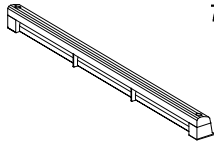

7401⁵²
S 7000 IQ
S 7000 IQ plus

S 8000 IQ

S 9000

GECCO 3

NL plus

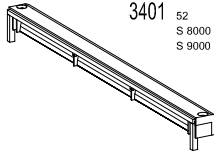

3401⁵²
S 8000 IQ
S 9000

Stulp

Sprossen

GECCO 4

Glasleisten

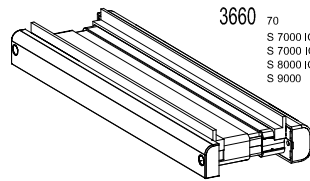

3660⁷⁰
S 7000 IQ
S 7000 IQ plus
S 8000 IQ
S 9000

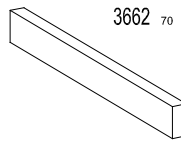

3662⁷⁰

Aussteifungen

Dichtungen

Rahmenverbreiterungen

Air Watch

Kopplungsprofile



3400⁹⁹

Eckprofile

Verleistungen

Untere Anschlussprofile

Laibungsverkleidungen

Schwellen

Lüftungssystem

Hebeschiebesysteme

Schiebesysteme

Rollladen / Cassonetto

RAE plus

Klappladen

Sonstiges

Hebeschiebesysteme · Lift-Slide systems

Hebe-Schiebe-Tür S 8000 IQ

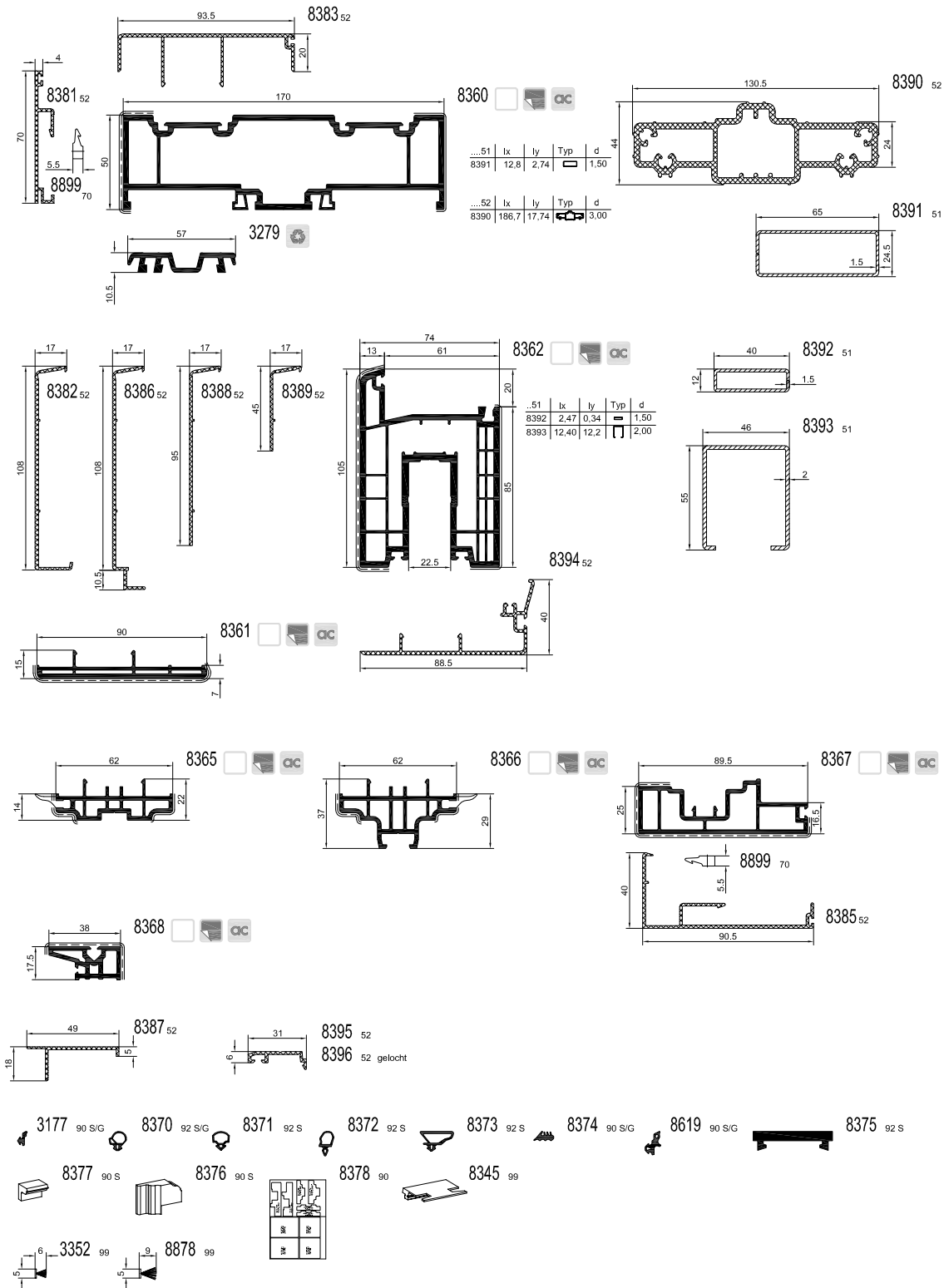

Zubehör Zarge umlaufend S 8000 IQ

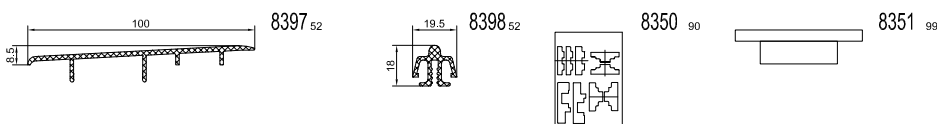

- S 3000
- S 7000 IQ
S 7000 IQ plus
- S 8000 IQ
- S 9000
- NL plus
- Stulp
- Sprossen
- Glasleisten
- Aussteifungen
- Dichtungen
- Rahmenverbreiterungen
- Kopplungsprofile
- Eckprofile
- Verleistungen
- Untere Anschlussprofile
- Laibungsverkleidungen
- Schwellen
- Lüftungssystem

Hebeschiebesysteme

- Schiebesysteme
- Rollladen / Cassonetto
- RAE plus
- Klappladen
- Sonstiges

Hebeschiebesysteme · Lift-Slide systems

Hebe-Schiebe-Tür S 9000

S 3000

S 7000 IQ
S 7000 IQ plus

S 8000 IQ

S 9000

NL plus

Stulp

Sprossen

Glasleisten

Aussteifungen

Dichtungen

Rahmenverbreiterungen

Kopplungsprofile

Eckprofile

Verleistungen

Untere Anschlussprofile

Laibungsverkleidungen

Schwellen

Lüftungssystem

Hebeschiebesysteme

Schiebesysteme

Rollladen / Cassonetto

RAE plus

Klappladen

Sonstiges

6351 52

6350 52

8899 70

6360

geplant / planned

...	lx	ly	Typ	d
6381	15,22	9,31		2,00
6380	27,26	17,60		3,00

6380 52

6381 51

6396 70

6381

6362

geplant / planned

...	lx	ly	Typ	d
6340	12,80	8,54		2,00
6383	12,53	8,93		2,00
6382	21,12	15,26		2,50

6341 52

6382 52

6340 51

6383 51

6354 52

6363

geplant / planned

...	lx	ly	Typ	d
6388	2,07	0,02		2,00

6342 52

6343 52

6388 51

6422 55

6361

geplant / planned

6368

geplant / planned

...	lx	ly	Typ	d
6386	0,02	0,03		1,25

6365

geplant / planned

6366

geplant / planned

6346 99

6365

6367

geplant / planned

6369

6355 52

6384 52

6378 99

6387 52

6359 52

6104 92 SIG

6106 90 S

6370 92 S

6371 92 S

6397 90 S

6373 99

6374 99

6375 90

6376 99

6395 99

Hebeschiebesysteme · Lift-Slide systems

Hebe-Schiebe-Tür S 9000

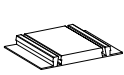

6377 92



6398 99



6399 99



6338 99



6345 99

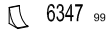

6347 99



6348 70



6349 99
6387

S 3000

S 7000 IQ
S 7000 IQ plus

S 8000 IQ

S 9000

NL plus

Stulp

Sprossen

Glasleisten

Aussteifungen

Dichtungen

Rahmenverbreiterungen

Kopplungsprofile

Eckprofile

Verleistungen

Untere Anschlussprofile

Laibungsverkleidungen

Schwellen

Lüftungssystem

Hebeschiebesysteme

Schiebesysteme

Rollladen / Cassonetto

RAE plus

Klappladen

Sonstiges

SF Schiebefenster · Sliding Window

S 3000

Schiebefenster

S 7000 IQ
S 7000 IQ plus

S 8000 IQ

S 9000

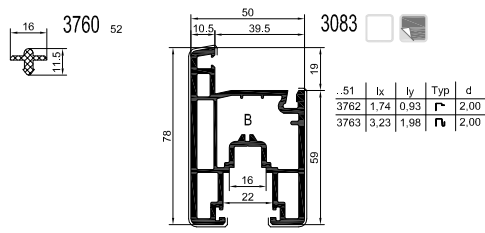
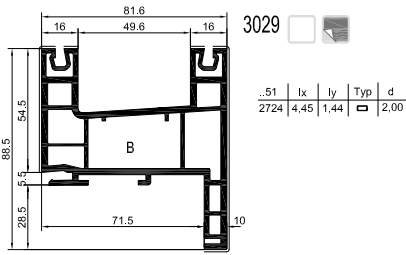

NL plus

Stulp

Sprossen

Glasleisten

Aussteifungen

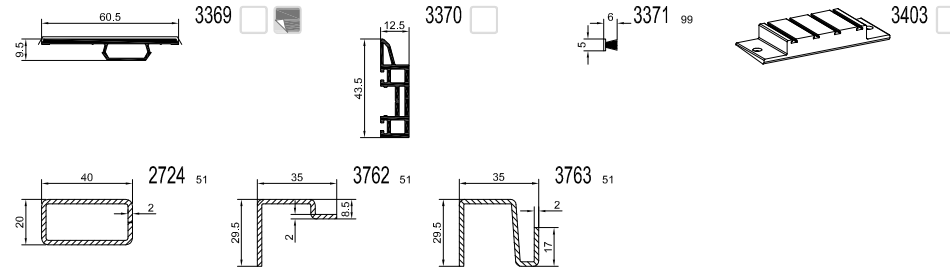

Dichtungen

Rahmenverbreiterungen

Kopplungsprofile

Eckprofile

Verleistungen

Untere Anschlussprofile

Laibungsverkleidungen

Schwellen

Lüftungssystem

Hebeschiebesysteme

Schiebesysteme

Rollladen / Cassonetto

RAE plus

Klappladen

Sonstiges

Schiebesysteme 74 mm

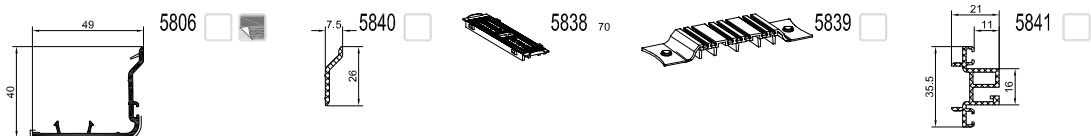
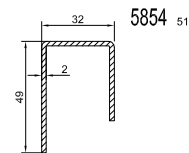
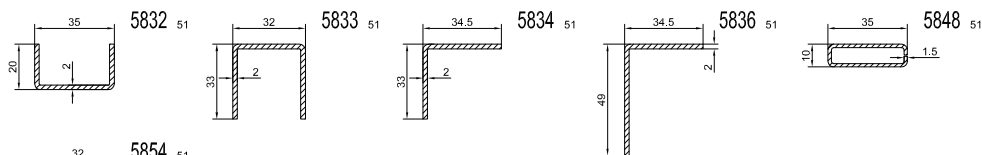
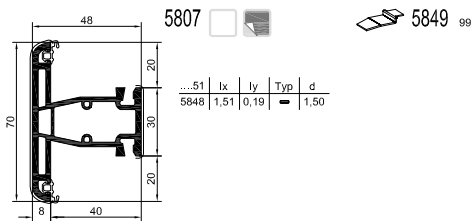
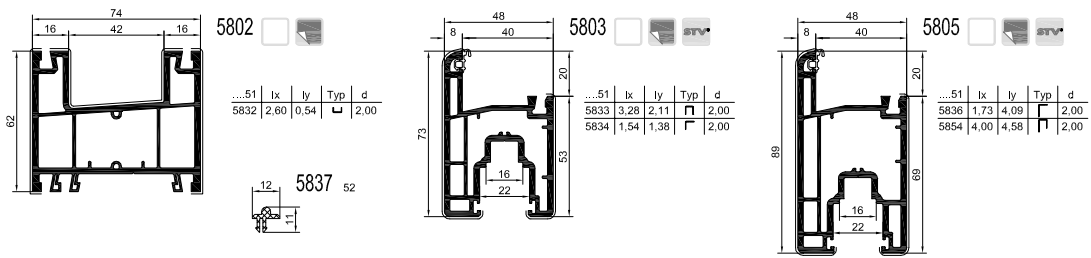

ST Schiebetür · Sliding Door

Schiebetür

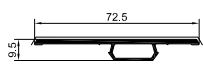
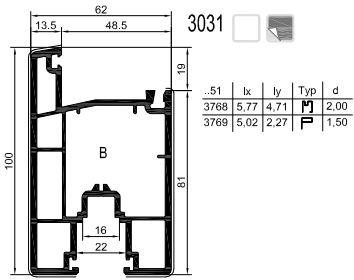
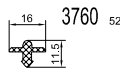
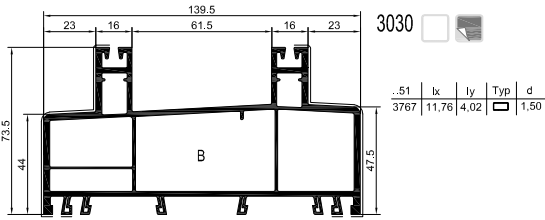

3032

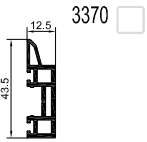

3370

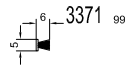

3371 99

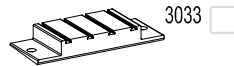

3033

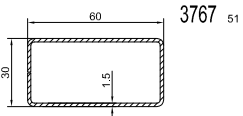

3767 51

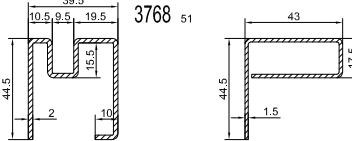

3768 51

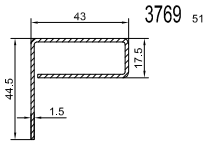

3769 51

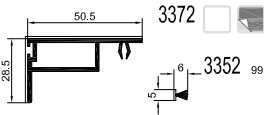

3372

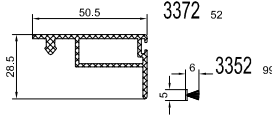

3372 52

- S 3000
- S 7000 IQ
S 7000 IQ plus
- S 8000 IQ
- S 9000
- NL plus
- Stulp
- Sprossen
- Glasleisten
- Aussteifungen
- Dichtungen
- Rahmenverbreiterungen
- Kopplungsprofile
- Eckprofile
- Verleistungen
- Untere Anschlussprofile
- Laibungsverkleidungen
- Schwellen
- Lüftungssystem
- Hebeschiebesysteme
- Schiebesysteme**
- Rollladen / Cassonetto
- RAE plus
- Klappladen
- Sonstiges

Rollladen · Roller Shutter

Rollladen

S 3000

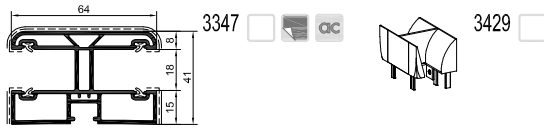

S 7000 IQ
S 7000 IQ plus

S 8000 IQ

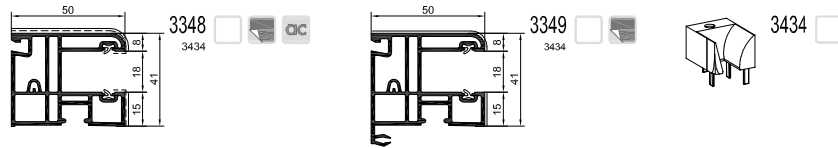

S 9000

NL plus

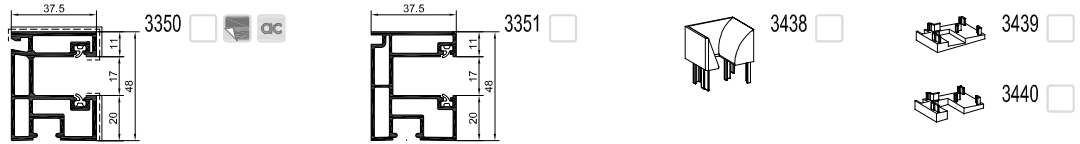

Stulp

Sprossen

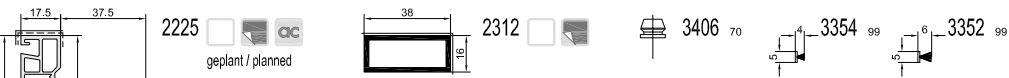

Glasleisten

Aussteifungen

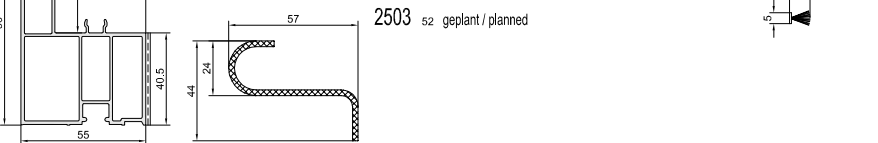

Dichtungen

Rahmenverbreiterungen



Kopplungsprofile

Eckprofile



Verleistungen

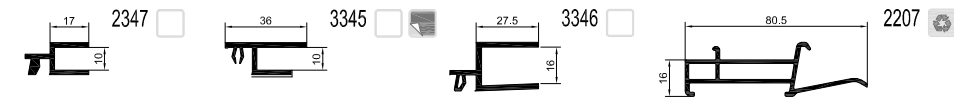

Untere Anschlussprofile

Laibungsverkleidungen

für 3347, 3348, 3349

Schwellen

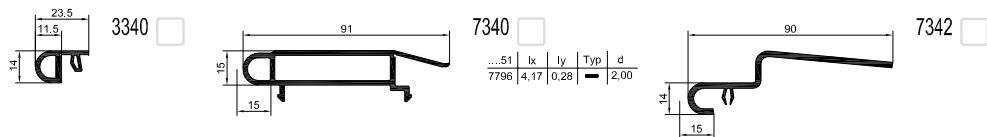

Lüftungssystem

Hebeschiebesysteme

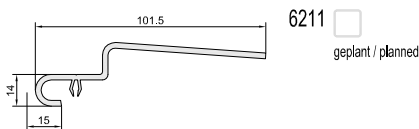

Schiebesysteme

für 3355, 3350, 3351

Rollladen / Cassonetto

RAE plus



Klappladen

Sonstiges

Rollladen · Roller Shutter

Rollladen Südeuropa

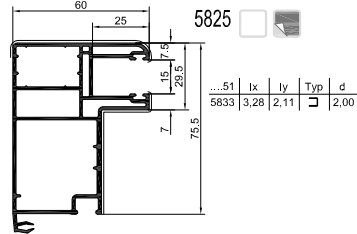
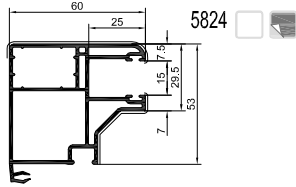
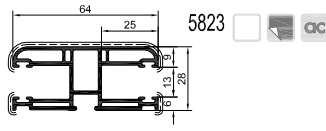
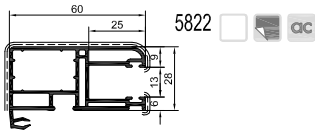

Cassonetto

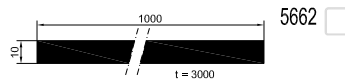
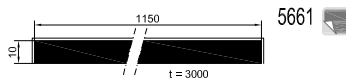
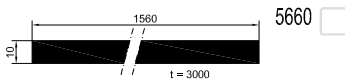
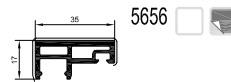
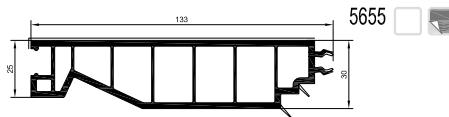
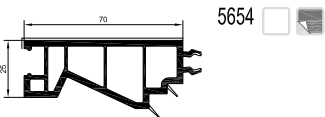

S 3000

S 7000 IQ
S 7000 IQ plus

S 8000 IQ

S 9000

NL plus

Stulp

Sprossen

Glasleisten

Aussteifungen

Dichtungen

Rahmenverbreiterungen

Kopplungsprofile

Eckprofile

Verleistungen

Untere Anschlussprofile

Laibungsverkleidungen

Schwellen

Lüftungssystem

Hebeschiebesysteme

Schiebesysteme

Rollladen / Cassonetto

RAE plus

Klappladen

Sonstiges

RAE plus · Roller Shutter plus

Rollladenaufsatzelement plus

S 3000

S 7000 IQ
S 7000 IQ plus

S 8000 IQ

S 9000

NL plus

Stulp

Sprossen

Glasleisten

Aussteifungen

Dichtungen

Rahmenverbreiterungen

Kopplungsprofile

Eckprofile

Verleistungen

Untere Anschlussprofile

Laibungsverkleidungen

Schwellen

Lüftungssystem

Hebeschiebesysteme

Schiebesysteme

Rollladen / Cassonetto

RAE plus

Klappladen

Sonstiges

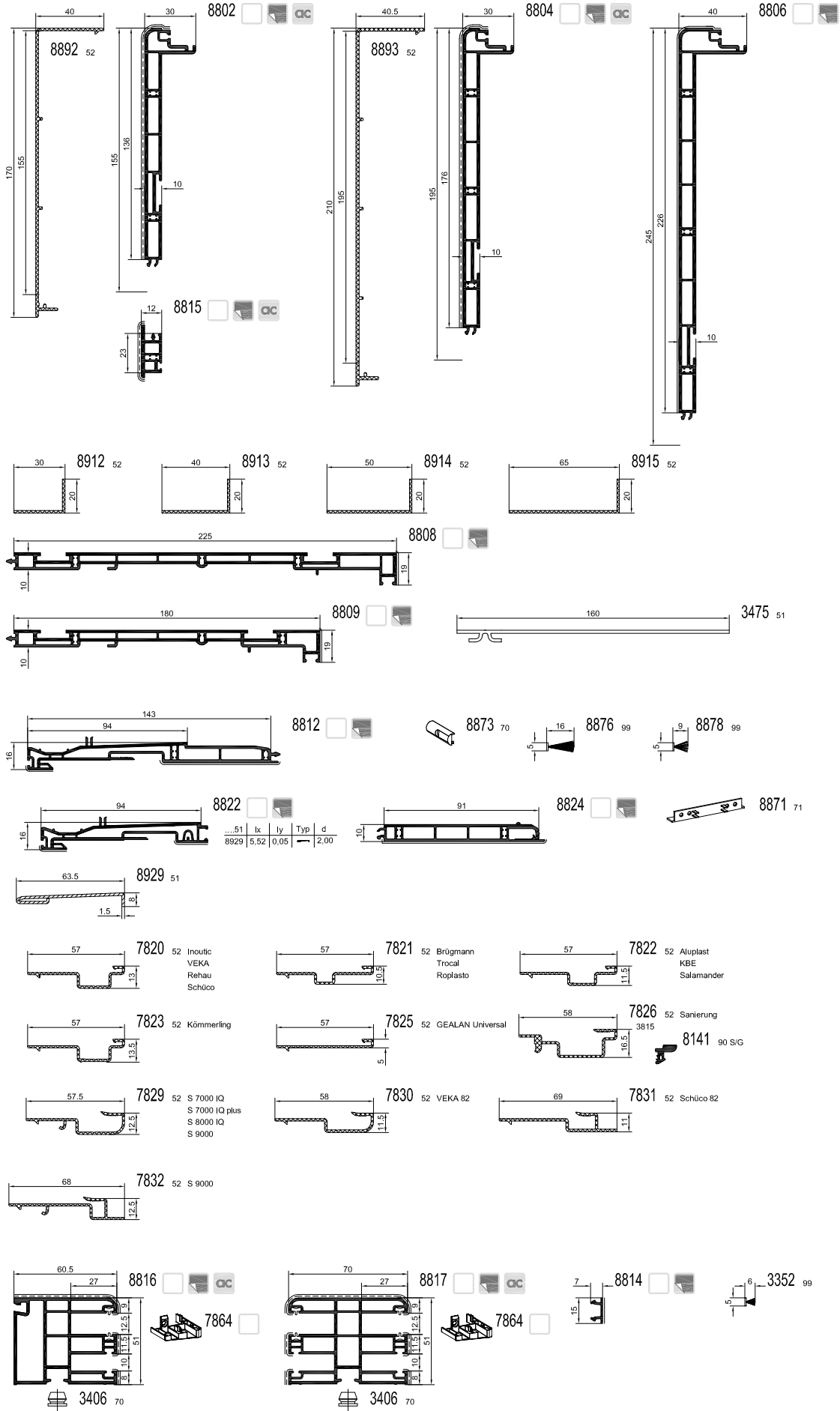

RAE plus · Roller Shutter plus

Rollladenaufsatzelement plus

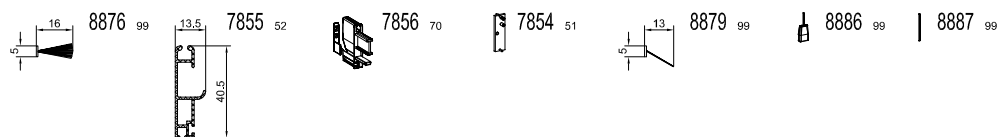
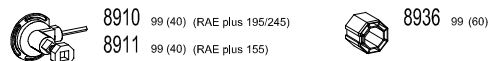
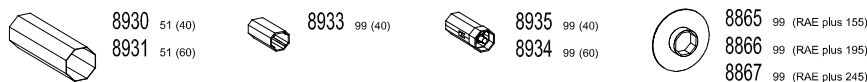
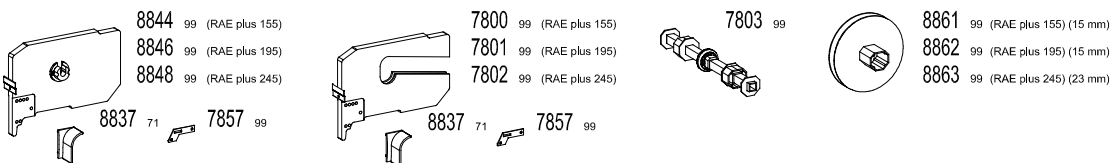
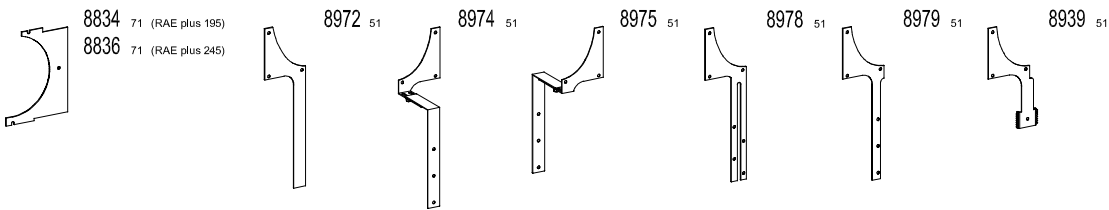
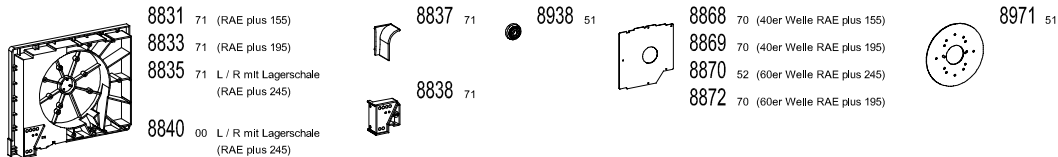
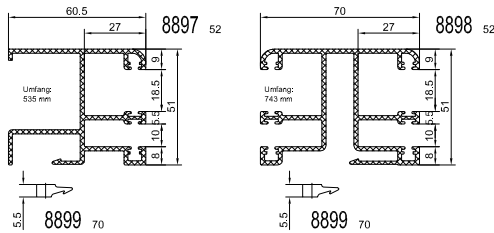
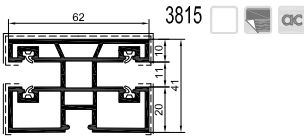
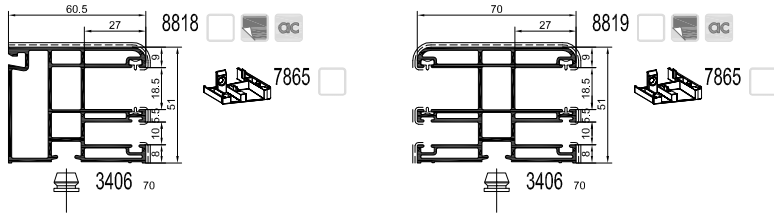

S 3000

S 7000 IQ
S 7000 IQ plus

S 8000 IQ

S 9000

NL plus

Stulp

Sprossen

Glasleisten

Aussteifungen

Dichtungen

Rahmenverbreiterungen

Kopplungsprofile

Eckprofile

Verleistungen

Untere Anschlussprofile

Laibungsverkleidungen

Schwellen

Lüftungssystem

Hebeschiebesysteme

Schiebesysteme

Rollladen / Cassonetto

RAE plus

Klappladen

Sonstiges

RAE plus · Roller Shutter plus

Rollladenaufsatzelement plus

S 3000

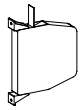

8881 99 (15 mm)
8882 99 (23 mm)



8874 71

S 7000 IQ
S 7000 IQ plus

S 8000 IQ

S 9000



8940 80 (PVC)



8946 80 (PVC)

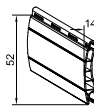

8950 80 (PVC)

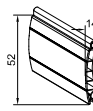

8956 80 (PVC)

NL plus



8941 52 (Alu)



8951 52 (Alu)



8944 99 (MINI)
8954 99 (MAXI)

Stulp

Sprossen

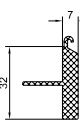

8943 52

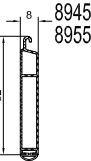

8945 52 (MINI)
8955 52 (MAXI)



8890 99 (MINI)
8891 99 (MAXI)



8958 70

Glasleisten

Aussteifungen

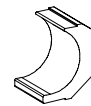

8854 99 (RAE plus 155)
8855 99 (RAE plus 195)
8859 99 (RAE plus 245)

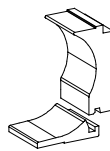

8986 99 (RAE plus 195)
8987 99 (RAE plus 245)

Dichtungen

Rahmenverbreiterungen

Kopplungsprofile

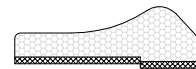

8980 99 (RAE plus 155)
8981 99 (RAE plus 195/245)

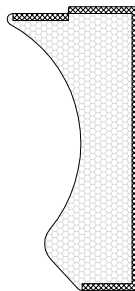

8982 99 (RAE plus 155)
8983 99 (RAE plus 195)
8984 99 (RAE plus 245)

Eckprofile

Verleistungen

Untere Anschlussprofile

Laibungsverkleidungen

Schwellen

Lüftungssystem

Hebeschiebesysteme

Schiebesysteme

Rollladen / Cassonetto

RAE plus

Klappladen

Sonstiges

Klappladen · Folding Shutter

Klappladen

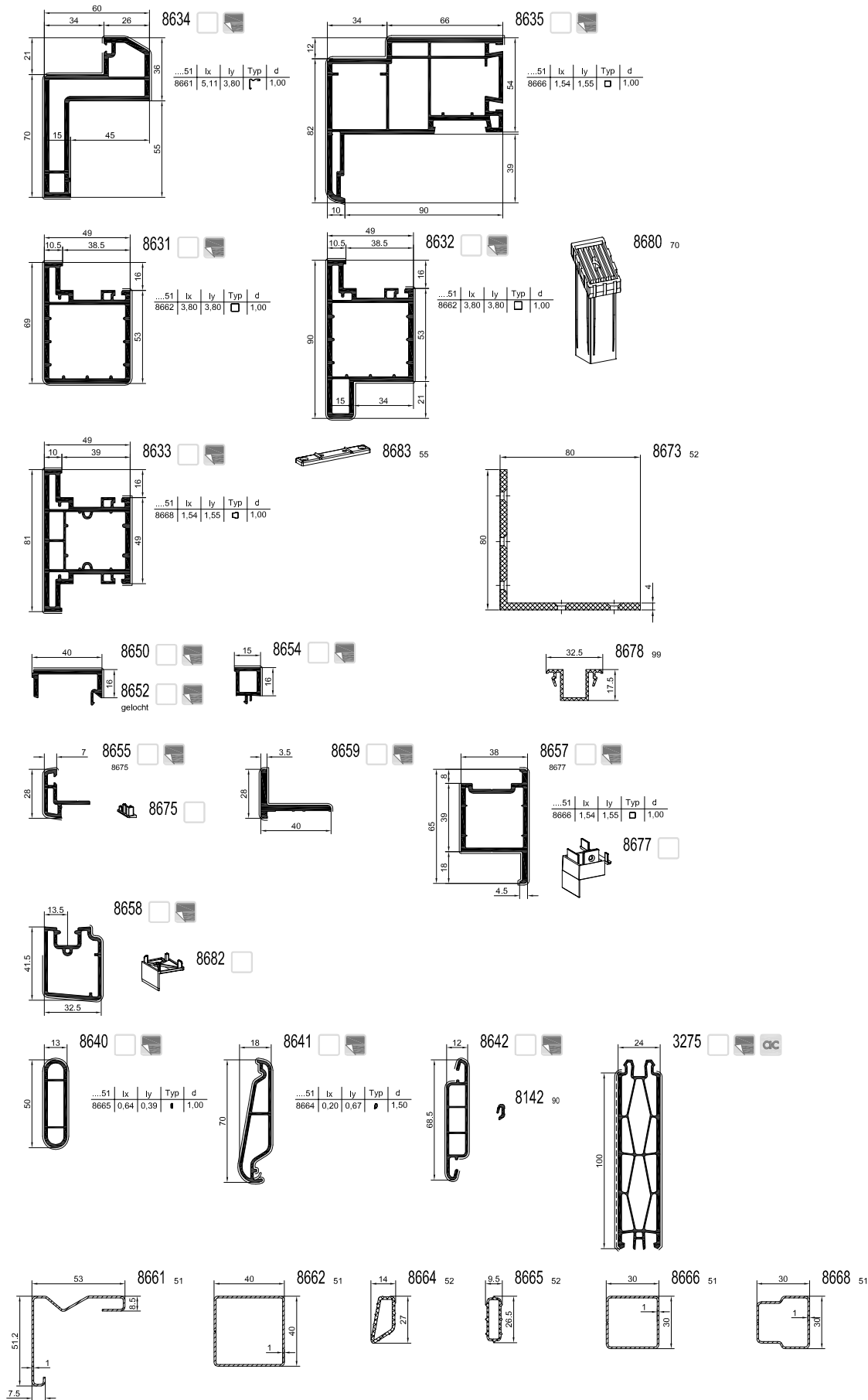

- S 3000
- S 7000 IQ
S 7000 IQ plus
- S 8000 IQ
- S 9000
- NL plus
- Stulp
- Sprossen
- Glasleisten
- Aussteifungen
- Dichtungen
- Rahmenverbreiterungen
- Kopplungsprofile
- Eckprofile
- Verleistungen
- Untere Anschlussprofile
- Laibungsverkleidungen
- Schwellen
- Lüftungssystem
- Hebeschiebesysteme
- Schiebesysteme
- Rollladen / Cassonetto
- RAE plus
- Klappladen**
- Sonstiges

Klappladen · Folding Shutter

Klappladen

S 3000

S 7000 IQ
S 7000 IQ plus

S 8000 IQ

S 9000

NL plus

Stulp

Sprossen

Glasleisten

Aussteifungen

Dichtungen

Rahmenverbreiterungen

Kopplungsprofile

Eckprofile

Verleistungen

Untere Anschlussprofile

Laibungsverkleidungen

Schwellen

Lüftungssystem

Hebeschiebesysteme

Schiebesysteme

Rollladen / Cassonetto

RAE plus

Klappladen

Sonstiges

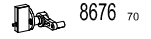
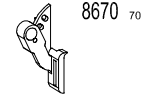
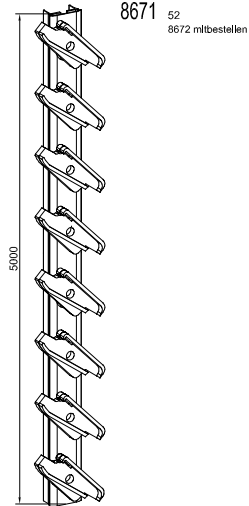
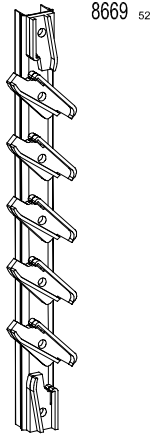

Sonstiges · Miscellaneous

Sonstiges

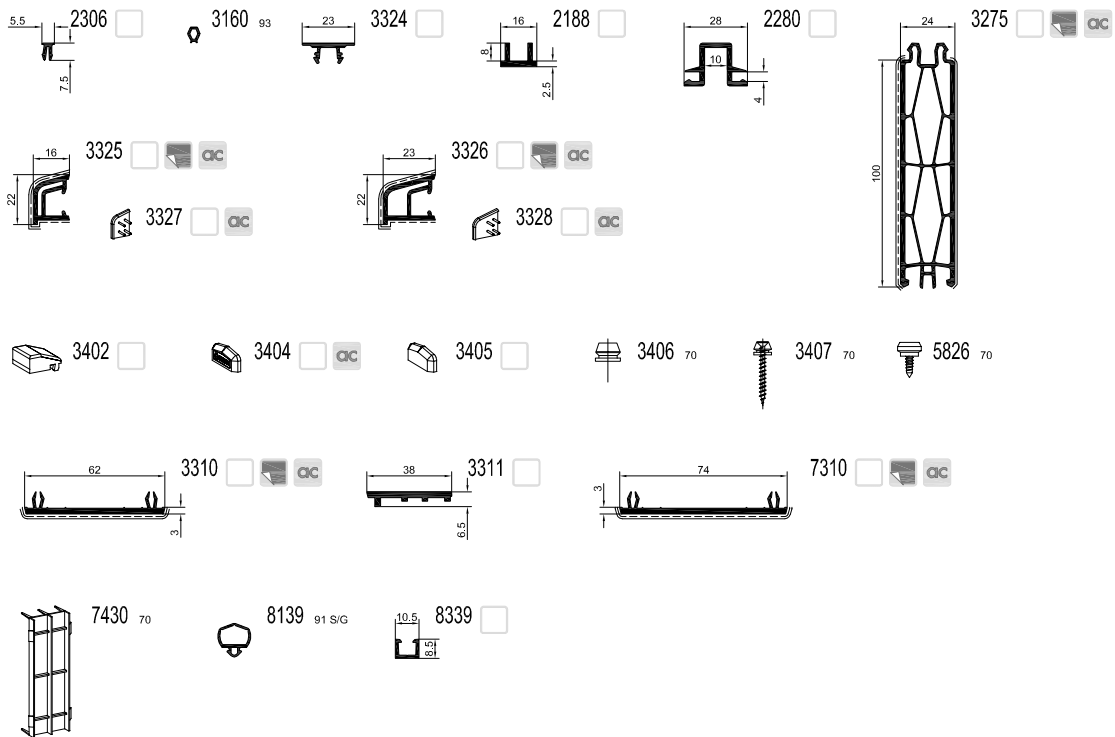

Falztiefe 40 mm

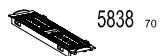

Falztiefe 48,5 mm



Falztiefe 61 mm



Falztiefe 67,5 mm



Falztiefe 69 mm



Maueranker

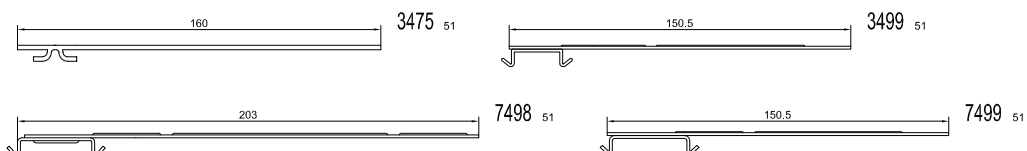

S 3000

S 7000 IQ
S 7000 IQ plus

S 8000 IQ

S 9000

NL plus

Stulp

Sprossen

Glasleisten

Aussteifungen

Dichtungen

Rahmenverbreiterungen

Kopplungsprofile

Eckprofile

Verleistungen

Untere Anschlussprofile

Laibungsverkleidungen

Schwellen

Lüftungssystem

Hebeschiebesysteme

Schiebesysteme

Rollladen / Cassonetto

RAE plus

Klappladen

Sonstiges

Art.-Nr.	Benennung	Seiten
2016	Kopplungsprofil	18
2101	Unterer Anschluss	35
2131	Glasleiste	25
2144	Dichtung	29
2149	Dichtung	29
2150	Dichtung	29
2155	Dichtung	30
2160	Klebeband	30
2167	Dichtung	29
2172	Dichtung	30, 33
2188	Kammerbrücke	53
2203	Außenfensterbank	36
2207	Aufnahmepprofil	34, 46
2209	Außenfensterbank	35
2211	Unterer Anschluss	35
2212	Unterer Anschluss	35
2213	Außenfensterbank	35
2217	Verblendleiste	34
2219	Außenfensterbank	36
2220	Verblendleiste	34
2221	Außenfensterbank	35
2225	Adapterprofil	46
2226	Verblendleiste	34
2230	Unterer Anschluss	35
2233	Rundprofil	33
2234	Rundrohradapter	33
2237	Abdeckwinkel	34, 35
2238	Winkelprofil	34
2239	Abdeckwinkel	35
2241	Verblendleiste	34
2243	Verblendleiste	34
2247	Verblendleiste	34
2249	Lisenenprofil	32
2251	Winkelprofil	34
2253	Winkelprofil	34
2254	Verblendleiste	34
2255	Knickleiste	34
2257	Verblendleiste	34
2263	Verblendleiste	34
2266	Laibungsverkleidung	37
2268	Laibungsverkleidung	37
2269	Laibungsverkleidung	37
2270	Laibungsverkleidung	37
2271	Laibungsverkleidung	37
2272	Verblendleiste	34
2273	Verblendleiste	34
2280	Kopplungsprofil	53
2282	Kopplungsprofil	32
2296	Blendrahmenverbreiterung	18
2304	Eckprofil	33
2306	Nutenfüller	53
2311	Blendrahmenverbreiterung	31
2312	Ausgleichsprofil	34, 46
2313	Blendrahmenverbreiterung	31
2315	Blendrahmenverbreiterung	31

Art.-Nr.	Benennung	Seiten
2316	Verblendleiste	34
2325	Verblendleiste	33, 34
2326	Lisenenprofil	32
2327	Kopplungsprofil	32
2328	Abdeckprofil	32
2347	Einschubleiste	46
2413	Montagehilfe	32
2503	Abrolltraverse	46
2576	Abdeckprofil	38, 39
2580	Bürstendichtung	30, 38
2587	Bürstendichtung	30, 38
2590	Bürstendichtung	38
2591	Endkappe	38
2592	Stulpkappe	38
2593	Stulpkappe	38
2595	Schwelle	38
2596	Schwelle	39
2597	Aluleiste	38
2703	Aussteifung	26
2720	Aussteifung	26
2724	Aussteifung	18, 26, 44
2742	Aussteifung	18, 26
2756	Aussteifung	26
2770	Aussteifung	26
3002	Blendrahmen	3
3029	Blendrahmen	44
3030	Blendrahmen	45
3031	Flügel	45
3032	Abdeckprofil	45
3033	Dichtblock	45
3037	Pfosten	3
3080	Stulppprofil	19
3081	Flügel	3
3083	Flügel	44
3094	Flügel	3
3096	Flügel	3
3108	Glasleiste	25
3109	Glasleiste	25
3110	Glasleiste	25
3115	Glasleiste	25
3116	Glasleiste	25
3120	Glasleiste	25
3122	Dichtung	29
3123	Dichtung	29
3128	Glasleiste	25
3132	Glasleiste	25
3136	Glasleiste	25
3151	Dichtung	18, 30
3152	Dichtung	29, 44
3153	Dichtung	29
3156	Dichtung	30, 32
3158	Bürstendichtung	12, 30, 38
3160	Dichtung	30, 53
3162	Dichtung	29
3165	Dichtung	30, 32

Art.-Nr.	Benennung	Seiten
3167	Dichtung	29
3169	Dichtung	30, 32
3170	Dichtung	30, 32
3171	Dichtung	20, 22, 30
3172	Dichtung	30
3173	Dichtung	29
3177	Dichtung	24, 30, 41
3178	Dichtung	30, 31
3179	Dichtung	30, 32
3182	Glasfalzverbreiterung	25
3184	Dichtung	29, 30
3185	Dichtung	29
3195	Sprosse	24
3196	Sprosse	24
3197	Sprosse	24
3198	Sprosse	24
3204	Unterer Anschluss	35
3205	Unterer Anschluss	35
3206	Unterer Anschluss	35
3207	Außenfensterbank	35
3208	Unterer Anschluss	35
3210	Außenfensterbank	35
3215	Unterer Anschluss	35
3216	Unterer Anschluss	35
3217	Unterer Anschluss	35
3218	Verblendleiste	34
3229	Außenfensterbank	35
3230	Außenfensterbank	35
3232	Außenfensterbank	35
3234	Kopplungsprofil	18
3239	Abdeckwinkel	35
3240	Lisenenprofil	32
3244	Verblendleiste	34
3245	Verblendleiste	34
3246	Ausgleichsprofil	8
3250	Winkelprofil	34
3251	Winkelprofil	34
3252	Winkelprofil	34
3253	Winkelprofil	34
3254	Winkelprofil	34
3258	Verblendleiste	34
3260	Verblendleiste	34
3261	Verblendleiste	34
3262	Verblendleiste	34
3263	Verblendleiste	34
3264	Verblendleiste	34
3265	Verblendleiste	34
3268	Laibungsverkleidung	37
3269	Laibungsverkleidung	37
3270	Laibungsverkleidung	37
3271	Laibungsverkleidung	37
3275	Füllprofil	51, 53
3279	Adapterprofil	41
3283	Nutenfüller	30
3284	Kopplungsprofil	32

Art.-Nr.	Benennung	Seiten
3289	Blendrahmenverbreiterung	31
3290	Blendrahmenverbreiterung	31
3292	Abdeckprofil	32
3296	Blendrahmenverbreiterung	8
3297	Ausgleichsprofil	8
3299	Balkonanschlussprofil	35
3308	Deckleiste	19, 20
3310	Blendrahmen-Abdeckung	53
3311	Glasfalzabdeckung	53
3313	Stulpschlagleiste	20
3314	Stulpschlagleiste	20
3324	Kammerbrücke	53
3325	Wetterschenkel	53
3326	Wetterschenkel	53
3327	Endkappe	53
3328	Endkappe	53
3340	Abrolltraverse	46
3342	Abrolltraverse	46
3345	Einschubleiste	46
3346	Einschubleiste	46
3347	Führungsschiene	46
3348	Führungsschiene	46
3349	Führungsschiene	46
3350	Führungsschiene	46
3351	Führungsschiene	46
3352	Bürstendichtung	30, 41, 45, 46, 48
3354	Bürstendichtung	30, 46
3355	Führungsschiene	46
3356	Ausgleichsprofil	46
3357	Ausgleichsprofil	46
3362	Unterer Anschluss	35
3369	Abdeckprofil	44
3370	Dichtleiste	44, 45
3371	Bürstendichtung	30, 44, 45
3372	Abdeckprofil	45
337252	Abdeckprofil	45
3400	GEALAN Airwatch	40
3401	GECCO 3	40
3402	Auflaufbock	53
3403	Dichtblock	44
3404	Wasserschlitzkappen	53
3405	Wasserschlitzkappen	53
3406	Klemmnippel	46, 48, 53
3407	Klemmnippel	53
3408	Glasfalzeinlage	53
3410	Glasfalzeinlage	53
3413	Schrägpfostenverbinder	3
3414	Verbinder	8
3416	Stulpkappe	20
3418	Stulpkappe	20
3421	Endkappe	20
3429	Einlauftrichter	46
3434	Einlauftrichter	46
3436	Einlauftrichter	46
3438	Einlauftrichter	46

Art.-Nr.	Benennung	Seiten
3439	Endkappe	46
3440	Endkappe	46
3451	Trittschutzschiene	39
3458	Trittschutzschiene	39
3461	Koppelschraube	32
3473	Falzeckwinkel	3
3475	Maueranker	48, 53
3476	Schraubenset	5
3477	Schraubenset	3
3482	Koppelschraube	32
3483	Hülsenmutter	32
3492	Pfostenverbinder	3
3493	Kreuzverbinder	3
3499	Maueranker	53
3510	Stulpkappe	19
3511	Stulpkappe	19
3532	Trittschutzschiene	38
3559	Montagehilfe	32
3561	Glasfalzanschlagprofil	32
3562	Glasfalzanschlagprofil	32
3563	Glasfalzeinlage	32
3587	Endkappe	35
3588	Endkappe	35
3660	GECCO 4	40
3662	GECCO 4	40
3702	Aussteifung	26
3704	Aussteifung	26
3710	Aussteifung	26
3712	Aussteifung	26
3720	Aussteifung	26
3721	Aussteifung	26
3723	Aussteifung	26
3728	Aussteifung	26
3735	Aussteifung	26
3754	Aussteifung	26
3760	Alu-Laufschiene	44, 45
3762	Aussteifung	26, 44
3763	Aussteifung	26, 44
3764	Aussteifung	26
3765	Aussteifung	26
3766	Aussteifung	26
3767	Aussteifung	26, 45
3768	Aussteifung	26, 45
3769	Aussteifung	26, 45
3798	Aussteifung	26
3802	Blende	34
3815	Führungsschiene	49
4794	Aussteifung	26
5002	Blendrahmen	4
5006	Pfosten	5
5007	Flügel	6
5010	Blendrahmen	4
5011	Flügel	6
5012	Flügel	6
5013	Pfosten	5

Art.-Nr.	Benennung	Seiten
5015	Sprosse	24
5019	Monostulp	20
5051	Blendrahmen	4
5101	Dichtplatte	30, 31
5102	Dichtplatte	24
5201	Blendrahmenverbreiterung	31
5202	Blendrahmenverbreiterung	31
5203	Blendrahmenverbreiterung	31
5204	Kopplungsprofil	32
5205	Unterer Anschluss	36
5206	Rundprofil	33
5207	Rundrohradapter	33
5209	Stulpprofil	20
5210	Abrolltraverse	46
5211	Glasfalzverbreiterung	25
5212	Glasfalzverbreiterung	25
5213	Blendrahmenverbreiterung	31
5214	Stulpprofil	20
5403	Alu-Vorsatzschale	6
5404	Alu-Vorsatzschale	5
5406	Trittschutzschiene	39
5408	Glasfalzeinlage	53
5410	Stulpkappe	20
5413	Alu-Vorsatzschale	20
5415	Set-Schwellenverbinder	39
5417	Stulpkappe	20
5418	Abdeckkappe	20
5419	Alu-Vorsatzschale	5
5500	Monoblock	7
5501	Monoblock	7
5502	Monoblock	8
5503	Monoblock	8
5504	Blendrahmen	9
5505	Blendrahmen	9
5507	Blendrahmen	9
5510	Flügel	13
5511	Monostulp	21
5512	Flügel	13
5513	Monostulp	22
5515	Blendrahmen	9
5516	Blendrahmen	9
5517	Monoblock	8
5518	Ausgleichsprofil	9
5520	Ausgleichsprofil	8, 9
5521	Ausgleichsprofil	8, 9
5522	Stulpprofil	20
5523	Stulpschlagleiste	20
5524	Glasleiste	25
5525	Glasleiste	25
5526	Glasleiste	25
5527	Stulpschlagleiste	20
5560	Stulpkappe	20
5561	Stulpkappe	20
5563	Endkappe	7, 8
5564	Abdeckkappe	8, 9

Art.-Nr.	Benennung	Seiten
5565	Abdeckkappe	9
5566	Stulpkappe	20
5654	Basisprofil	47
5655	Basisprofil	47
5656	Ecken- und Rahmenprofil	47
5660	Füllprofil	47
5661	Füllprofil	47
5662	Füllprofil	47
5700	Aussteifung	26
5802	Blendrahmen	44
5803	Flügel	44
5805	Flügel	44
5806	Labyrinthprofil	44
5807	Sprosse	44
5822	Führungsschiene	47
5823	Führungsschiene	47
5824	Führungsschiene	47
5825	Führungsschiene	47
5826	Klemmnippel	47, 53
5832	Aussteifung	26, 44
5833	Aussteifung	26, 44
5834	Aussteifung	26, 44
5836	Aussteifung	26, 44
5837	Alu-Laufschiene	44
5838	Glasfalzeinlage	44, 53
5839	Dichtblock	44
5840	Adapter	44
5841	Stulpprofil	44
5848	Aussteifung	26, 44
5849	Dichtplatte	44
5854	Aussteifung	44
6001	Blendrahmen	14
6002	Blendrahmen	14
6003	Flügel	16
6012	Stulpprofil	22
6015	Blendrahmen	14
6016	Blendrahmen	14
6017	Flügel	16
6020	Stulpprofil	22
6021	Pfosten	15
6022	Pfosten	15
6023	Flügel	16
6025	Flügel	16
6027	Flügel	16
6029	Monostulp	23
6031	Blendrahmen	14
6032	Blendrahmen	14
6033	Flügel	16
6034	Blendrahmen-Aufsatz	16
6035	Blendrahmen	14
6036	Blendrahmen	14
6039	Flügel	16
6042	Stulpprofil	22
6045	Blendrahmen	14
6047	Blendrahmen	14

Art.-Nr.	Benennung	Seiten
6048	Blendrahmen	14
6049	Pfosten	15
6050	Pfosten	15
6053	Pfosten	15
6054	Pfosten	15
6101	Dichtung	29
6104	Dichtung	29, 42
6105	Bürstendichtung	30, 39
6106	Dichtung	29, 42
6108	Glasleiste	25
6112	Glasleiste	25
6116	Glasleiste	25
6124	Glasleiste	25
6126	Glasleiste	25
6128	Glasleiste	25
6130	Glasleiste	25
6132	Glasleiste	25
6134	Glasleiste	25
6136	Glasleiste	25
6138	Glasleiste	25
6140	Glasleiste	25
6142	Glasleiste	25
6144	Glasleiste	25
6146	Glasleiste	25
6148	Glasleiste	25
6150	Glasleiste	25
6151	Dichtung	29
6152	Glasleiste	25
6153	Dichtung	29
6211	Abrolltraverse	46
6281	Kopplungsprofil	32
6301	Stulpschlagleiste	22
6338	Dichtblock	43
6340	Aussteifung	26, 42
6341	Alu-Vorsatzschale	42
6342	Alu-Vorsatzschale	42
6343	Alu-Vorsatzschale	42
6345	Dichtblock	43
6346	Dichtblock	42
6347	Dichtblock	43
6348	Dichtblock	43
6349	Dichtblock	43
6350	Alu-Vorsatzschale	42
6351	Alu-Vorsatzschale	42
6354	Alu-Vorsatzschale	42
6355	Alu-Vorsatzschale	42
6359	Aluleiste	42
6360	Blendrahmen	42
6361	PVC-Profil	42
6362	Flügel	42
6363	Blendrahmen	42
6365	PVC-Profil	42
6366	PVC-Profil	42
6367	PVC-Profil	42
6368	Labyrinthprofil	42

Art.-Nr.	Benennung	Seiten
6369	PVC-Profil	42
6370	Dichtung	30, 42
6371	Dichtung	30, 42
6373	Bürstendichtung	30, 42
6374	Bürstendichtung	30, 42
6375	Dichtplatte	42
6376	Dichtplatte	42
6377	Dichtblock	43
6378	Führungsgleiter	42
6380	Alu-Aussteifung	26, 42
6381	Aussteifung	26, 42
6382	Alu-Aussteifung	26, 42
6383	Aussteifung	26, 42
6384	Aluschiene	42
6386	Aussteifung	26, 42
6387	Aluleiste	42
6388	Aussteifung	26, 42
6395	Dichtplatte	42
6396	Verbinder	42
6397	Dichtung	42
6398	Dehnungsausgleichsblock	43
6399	Dehnungsausgleichsblock	43
6403	Stulpkappe	22
6404	Glasfalzeinlage	53
6407	Schweißeckverbinder	16
6409	Schweißeckverbinder	16
6414	Schraubenset	15
6416	Pfostenverbinder	15
6417	Kreuzverbinder	15
6418	Pfostenverbinder	15
6419	Schraubenset	15
6420	Schrägpfostenverbinder	15
6422	Falzeckwinkel	15, 42
6423	Stulpkappe	22
6424	Abdeckkappe	23
6425	Stulpkappe	22
6426	Stulpkappe	22
6427	Stulpkappe	22
6428	Stulpkappe	22
6429	Set-Schwellenverbinder	39
6430	Schwellenverbinder	39
6431	Wetterschenkel	39
6432	Stulpkappe	39
6433	Endkappe	39
6434	Schwellenverbinder	39
6435	Stulpkappe	39
6436	Aluleiste	39
6440	Stulpkappe	22
6441	Pfostenverbinder	15
6442	Pfostenverbinder	15
6443	Pfostenverbinder	15
6444	Pfostenverbinder	15
6445	Schrägpfostenverbinder	15
6446	Kreuzverbinder	15
6447	Stulpkappe	39

Art.-Nr.	Benennung	Seiten
6449	Stulpkappe	39
6450	Stulpstopfen	39
6454	Koppelschraube	32
6455	Koppelschraube	32
6456	Koppelschraube	32
6457	Dichtblock	39
6458	Schwellenverbinder	39
6460	Dichtplatte	15
6461	Dichtplatte	15
6617	Alu-Vorsatzschale	14
6618	Alu-Vorsatzschale	14
6619	Alu-Vorsatzschale	16
6620	Alu-Vorsatzschale	16
6621	Alu-Vorsatzschale	16
6622	Alu-Vorsatzschale	15
6623	Alu-Vorsatzschale	15
6624	Alu-Vorsatzschale	22
6625	Alu-Vorsatzschale	22
6626	Alu-Vorsatzschale	22
6627	Alu-Vorsatzschale	14
6628	Alu-Vorsatzschale	22
6629	Alu-Vorsatzschale	22
6630	Alu-Vorsatzschale	15
6631	Alu-Vorsatzschale	15
6705	Aussteifung	26
6706	Aussteifung	26
6708	Aussteifung	26
6709	Aussteifung	26
6711	Aussteifung	26
6712	Aussteifung	26
6713	Aussteifung	26
6714	Aussteifung	26
6715	Aussteifung	26
6716	Aussteifung	26
6717	Aussteifung	26
6718	Aussteifung	26
6720	Aussteifung	26
6721	Aussteifung	26
6722	Aussteifung mit Schlossfräsung	26
6725	Aussteifung	26
6726	Aussteifung	26
6727	Aussteifung	27
6728	Aussteifung	27
6729	Aussteifung	27
6730	Aussteifung	27
6733	Aussteifung	27
6736	Aussteifung	27
6737	Aussteifung	27
6738	Aussteifung	27
6742	Aussteifung	27
6743	Aussteifung	27
6744	Aussteifung	27
6745	Aussteifung	27
6746	Aussteifung	27
6747	Aussteifung	27

Art.-Nr.	Benennung	Seiten
7008	Blendrahmen	4
7011	Blendrahmen	4
7014	Blendrahmen	4
7026	Blendrahmen	4
7030	Blendrahmen	4
7035	Sprosse	24
7036	Sprosse	24
7037	Pfosten	5, 19
7043	Pfosten	5
7066	Flügel	6
7069	Monostulp	19
7080	Stulpprofil	20
7081	Flügel	6
7093	Flügel	6
7111	Glasleiste	25
7116	Glasleiste	25
7118	Glasleiste	25
7119	Glasleiste	25
7122	Glasleiste	25
7128	Glasleiste	25
7129	Glasleiste	25
7130	Glasleiste	25
7134	Glasleiste	25
7138	Glasleiste	25
7139	Glasleiste	25
7142	Glasleiste	25
7144	Glasleiste	25
7146	Glasleiste	25
7149	Dichtung	29
7151	Dichtung	29
7154	Glasleiste	25
7156	Glasleiste	25
7157	Dichtung	29
7158	Dichtung	29
7159	Dichtung	18, 29, 38, 39
7160	Dichtplatte	30, 31
7161	Dichtung	5, 30
7162	Glasleiste	25
7164	Glasleiste	25
7180	Glasleiste	25
7181	Glasfalzverbreiterung	25
7201	Unterer Anschluss	36
7202	Unterer Anschluss	36
7205	Unterer Anschluss	36
7206	Unterer Anschluss	36
7209	Unterer Anschluss	36
7213	Außenfensterbank	35
7281	Kopplungsprofil	32
7288	Balkonanschlussprofil	36
7289	Blendrahmenverbreiterung	31
7290	Blendrahmenverbreiterung	31
7291	Kopplungsprofil	32
7292	Blendrahmenverbreiterung	31
7298	Blendrahmenverbreiterung	31
7299	Balkonanschlussprofil	36

Art.-Nr.	Benennung	Seiten
7300	Stulpprofil	19
7302	Stulpprofil	19
7303	Stulpprofil	19
7309	Stulpschlagleiste	19
7310	Blendrahmen-Abdeckung	53
7340	Abrolltraverse	46
7341	Abrolltraverse	46
7342	Abrolltraverse	46
7401	GECCO 2	40
7407	Glasfalzeinlage	53
7408	Glasfalzeinlage	53
7410	Glasfalzeinlage	53
7411	Schrägpfostenverbinder	5
7413	Schrägpfostenverbinder	24
7414	Stulpkappe	19
7416	Stulpkappe	19
7418	Stulpkappe	19
7419	Gegenstück	19
7422	Stulpkappe	19
7423	Stulpkappe	19, 20
7424	Stulpkappe	19, 20
7425	Stulpkappe	19
7430	Montagefalzklotz	53
7431	Kopplungsfalzklötz	32
7434	Stulpkappe	20
7435	Stulpkappe	20
7459	Trittschutzschiene	38, 39
7460	Aluleiste	38
7473	Falzeckwinkel	10, 18, 24
7476	Schraubenset	10, 24
7478	Schraubenset	24
7479	Schraubenset	5
7481	Schwelle	38
7482	Koppelschraube	32
7483 52	Schwelle	38
7483 70	Schwelle	38
7484	Schwelle	38
7485	Abdeckprofil	38
7486	Sprossenverbinder	24
7490	Pfostenverbinder	5
7491	Kreuzverbinder	5
7492	Pfostenverbinder	5
7493	Pfostenverbinder	5
7497	Pfostenverbinder	10, 24
7498	Maueranker	18,53
7499	Maueranker	18,53
7500	Verbinder	34
7501	Maueranker	18
7503	Alu-Vorsatzschale	4
7504	Alu-Vorsatzschale	4
7505	Alu-Vorsatzschale	4
7507	Alu-Vorsatzschale	6
7508	Alu-Vorsatzschale	6
7509	Alu-Vorsatzschale	5
7510	Alu-Vorsatzschale	5, 19

Art.-Nr.	Benennung	Seiten
7511	Alu-Vorsatzschale	19
7512	Stulpkappe	19, 20
7513	Alu-Vorsatzschale	19
7514	Alu-Vorsatzschale	6
7523	Schwellenverbinder	38
7525	Set-Schwellenverbinder	38
7701	Aussteifung	27
7702	Aussteifung	27
7703	Aussteifung	27
7704	Aussteifung	27
7705	Aussteifung	27
7706	Aussteifung	27
7707	Aussteifung	27
7708	Aussteifung	27
7709	Aussteifung	27
7710	Aussteifung	27
7711	Aussteifung	27
7713	Aussteifung	27
7715	Aussteifung	27
7717	Aussteifung	27
7718	Aussteifung	27
7719	Aussteifung	27
7722	Aussteifung	27
7724	Aussteifung	27
7726	Aussteifung	27
7734	Aussteifung	27
7796	Aussteifung	27
7798	thermisch getrennte Aussteifung	27
7799	thermisch getrennte Aussteifung	27
7800	Mittellager	49
7801	Mittellager	49
7802	Mittellager	49
7803	Doppelwellenbolzen	49
7820	Verbindungsschiene	48
7821	Verbindungsschiene	48
7822	Verbindungsschiene	48
7823	Verbindungsschiene	48
7825	Verbindungsschiene	48
7826	Verbindungsschiene	48
7829	Verbindungsschiene	48
7830	Verbindungsschiene	48
7831	Verbindungsschiene	48
7832	Verbindungsschiene	48
7854	Abdeckkappe	49
7855	Alu-Abschluss-Stab	49
7856	Set-Arretierung Insektenschutz	49
7857	Verstärkung für Mittellager	49
7858	Anschlag-/Endstopfen	49
7859	Set Federmechanik	49
7860	Set Federmechanik mit Bremse	49
7864	Endkappe	48
7865	Endkappe	49
8001	Blendrahmen	7
8006	Blendrahmen	7
8010	Blendrahmen	7

Art.-Nr.	Benennung	Seiten
8012	Blendrahmen	7
8013	Blendrahmen	7
8014	Blendrahmen	7
8015	Blendrahmen	7
8016	Blendrahmen	17
8018	Blendrahmen	17
8019	Blendrahmen	17
8020	Blendrahmen	18
8021	Blendrahmen	17
8023	Wechselfosten	17
8027	Blendrahmen	8
8028	Blendrahmen	8
8030	Blendrahmen	8
8031	Blendrahmen	8
8036	Pfosten	10, 24
8037	Pfosten	10
8038	Pfosten	10
8039	Pfosten	10
8040	Pfosten	10
8042	Flügel	13
8043	Pfosten	10
8055	Pfosten	18
8056	Wechselfosten	11
8057	Wechselfosten	17
8058	Pfosten	17
8059	Pfosten	17
8061	Adapterprofil	18
8063	Flügel	12
8068	Flügel	12
8069	Monostulp	21
8071	Monostulp	21
8072	Flügel	12
8073	Monostulp	21
8074	Monostulp	21
8076	Flügel	12
8077	Flügel	13
8078	Flügel	13
8079	Flügel	12
8080	Flügel	13, 21
8081	Flügel	12
8092	Flügel	12
8095	Flügel	13
8096	Flügel	13
8097	Flügel	12
8098	Monostulp	21
8139	Dichtung	30, 53
8141	Dichtung	30, 48
8142	Dichtung	30, 51
8150	Dichtung	29
8156	Dichtung	29
8176	Dichtung	30
8177	Dichtung	12, 13, 29
8178	Dichtung	29, 30, 38, 39
8186	Dichtung	29
8187	Dichtung	29

Art.-Nr.	Benennung	Seiten
8188	Dichtung	18, 30
8189	Dichtplatte	18
8273	Blendrahmen-Aufsatz	12, 13, 38
8300	Stulpprofil	20
8302	Stulpprofil	21
8304	Stulpprofil	21
8307	Adapterprofil	17
8308	Adapterprofil	18
8309	Stulpschlagleiste	20, 22
8339	Aufnahmeprofil	53
8345	Dichtblock	41
8350	Dichtplatte	41
8351	Dichtblock	41
8360	Blendrahmen	41
8361	Abdeckprofil	41
8362	Flügel	41
8365	Anschlagleiste	41
8366	Führungsleiste	41
8367	Dichtleiste	41
8368	Labyrinthprofil	41
8370	Dichtung	30, 41
8371	Dichtung	30, 41
8372	Dichtung	30, 41
8373	Dichtung	30, 41
8374	Dichtung	30, 41
8375	Zargendichtungsplatte	41
8376	Dichtung	41
8377	Dichtung	41
8378	Dichtung	41
8381	Alu-Vorsatzschale	41
8382	Alu-Vorsatzschale	41
8383	Alu-Vorsatzschale	41
8385	Alu-Vorsatzschale	41
8386	Alu-Vorsatzschale	41
8387	Alu-Vorsatzschale	41
8388	Alu-Vorsatzschale	41
8389	Alu-Vorsatzschale	41
8390	Alu-Aussteifung	41
8391	Aussteifung	27, 41
8392	Aussteifung	27, 41
8393	Aussteifung	27, 41
8394	Alu-Vorsatzschale	41
8395	Aluleiste	41
8396	Aluleiste	41
8397	Alu-Schwellenabdeckung	41
8398	Alu-Laufschiene	41
8401	Clipsverbinder	21
8411	Schrägpfostenverbinder	10
8412	Schrägpfostenverbinder	10
8415	Abdeckkappe	19, 21, 22
8431	Pfostenverbinder	17, 18
8441	Schweißleckverbinder	12, 13
8443	Schweißleckverbinder	12, 13
8459	Trittschutzschiene	39
8471	Schwelle	38

Art.-Nr.	Benennung	Seiten
8477	Schraubenset	10
8478	Schraubenset	10
8479	Schraubenset	10
8490	Pfostenverbinder	10
8491	Kreuzverbinder	10
8492	Pfostenverbinder	10
8493	Kreuzverbinder	10
8494	Pfostenverbinder	10
8495	Kreuzverbinder	10
8496	Pfostenverbinder	10
8497	Kreuzverbinder	10
8498	Pfostenverbinder	10
8499	Pfostenverbinder	10
8500	Kreuzverbinder	10
8505	Pfostenverbinder	10
8510	Stulpkappe	21
8511	Stulpkappe	21
8512	Stulpkappe	21
8513	Stulpkappe	21
8514	Stulpkappe	21
8515	Stulpkappe	21
8516	Stulpkappe	21
8521	Schwellenverbinder	38
8522	Schwellenverbinder	38
8523	Schwellenverbinder	38
8527	Schwellenverbinder	38
8528	Schwellenverbinder	38
8529	Schwellenverbinder	38
8538	Set-Schwellenverbinder	38
8539	Schwellenverbinder	38
8540	Schwellenverbinder	38
8541	Schwellenverbinder	38
8543	Set-Schwellenverbinder	38
8558	Montagehilfe	33
8601	Alu-Vorsatzschale	7, 8
8602	Alu-Vorsatzschale	7
8605	Alu-Vorsatzschale	7
8606	Stulpprofil	20
8607	Alu-Vorsatzschale	10, 24
8608	Alu-Vorsatzschale	10, 24
8609	Alu-Vorsatzschale	10
8611	Alu-Vorsatzschale	13
8612	Alu-Vorsatzschale	21
8613	Alu-Vorsatzschale	12, 21
8614	Alu-Vorsatzschale	12, 13, 21
8615	Alu-Vorsatzschale	12
8616	Alu-Vorsatzschale	12
8617	Alu-Vorsatzschale	21
8618	Alu-Vorsatzschale	21
8619	Dichtung	29, 41
8621	Stulpkappe	21
8622	Stulpkappe	21
8623	Alu-Vorsatzschale	12, 13
8624	Alu-Vorsatzschale	18
8625	Alu-Vorsatzschale	17

Art.-Nr.	Benennung	Seiten
8626	Alu-Vorsatzschale	12
8627	Alu-Vorsatzschale	12
8628	Alu-Vorsatzschale	13
8629	Alu-Vorsatzschale	17, 18
8630	Alu-Vorsatzschale	18
8631	Flügel	51
8632	Flügel	51
8633	Pfosten	51
8634	Klappladenzarge	51
8635	Blockzarge	51
8636	Alu-Vorsatzschale	17
8637	Alu-Vorsatzschale	21
8638	Alu-Vorsatzschale	21
8639	Alu-Vorsatzschale	10
8640	Klappladenlamelle	51
8641	Klappladenlamelle	51
8642	Klappladenlamelle-Endstab	51
8650	Lamellenhalteleiste	51
8652	Lamellenhalteleiste	51
8654	Glasleiste	51
8655	Stulpprofil	51
8657	Stulpprofil	51
8658	Stulpprofil	51
8659	Stulpprofil	51
8661	Aussteifung	27 51
8662	Aussteifung	27 51
8664	Alu-Aussteifung	27 51
8665	Alu-Aussteifung	27 51
8666	Aussteifung	27 51
8668	Aussteifung	27 51
8669	Aluschiene	52
8670	Verstellmechanismus	52
8671	Aluschiene	52
8672	Ausgleichsprofil	52
8673	Aluwinkel	51
8674	Drehknopf	52
8675	Stulpkappe	51
8676	Drehhebel	52
8677	Stulpkappe	51
8678	Aluleiste	51
8680	Schweißbeckverbinder	51
8682	Stulpkappe	51
8683	Sprossenverbinder	51
8701	Aussteifung	27
8702	Aussteifung	27
8703	Aussteifung	27
8704	Aussteifung	27
8705	Aussteifung	27
8706	Aussteifung	27
8707	Aussteifung	27
8708	Aussteifung	28
8710	Aussteifung	28
8713	Aussteifung	28
8714	Aussteifung	28
8715	Aussteifung	28

Art.-Nr.	Benennung	Seiten
8716	Aussteifung	28
8719	Aussteifung	28
8723	Aussteifung	18, 28
8724	Aussteifung	28
8726	Aussteifung	28
8727	Aussteifung	28
8732	Alu-Aussteifung	28
8733	Alu-Aussteifung	28
8736	Aussteifung	28
8737	Aussteifung	28
8751	Aussteifung	28
8753	Aussteifung	28
8754	Aussteifung	28
8757	Aussteifung	28
8758	Aussteifung	28
8760	Aussteifung	28
8761	Aussteifung	28
8764	Aussteifung	28
8768	Aussteifung	28
8769	Aussteifung	28
8770	Aussteifung	18, 28
8771	Aussteifung	18, 28
8772	Aussteifung	18, 28
8774	Aussteifung	18, 28
8775	Aussteifung	18, 28
8776	Aussteifung	18, 28
8777	Aussteifung	28
8778	Aussteifung	18, 28
8783	Aussteifung	18, 28
8786	Aussteifung	28
8787	Aussteifung	28
8790	Aussteifung	28
8791	Aussteifung	28
8802	Blende	48
8804	Blende	48
8806	Blende	48
8808	Oberteil	48
8809	Oberteil	48
8812	Unterteil	48
8814	Abdeckprofil	48
8815	Ausgleichsprofil	48
8816	Führungsschiene	48
8817	Führungsschiene	48
8818	Führungsschiene	49
8819	Führungsschiene	49
8822	Unterteil	48
8824	Unterteil	48
8831	Kopfstück	49
8833	Kopfstück	49
8834	Abdeckplatte	49
8835	Kopfstück	49
8836	Abdeckplatte	49
8837	Einlauftrichter	49
8838	Adapter	49
8840	Kopfstück	49

Art.-Nr.	Benennung	Seiten
8844	Anschraublager	49
8846	Anschraublager	49
8848	Anschraublager	49
8854	Dämmung	50
8855	Dämmung	50
8859	Dämmung	50
8861	Gurtscheibe	49
8862	Gurtscheibe	49
8863	Gurtscheibe	49
8865	Begrenzungsscheibe	49
8866	Begrenzungsscheibe	49
8867	Begrenzungsscheibe	49
8868	Abweißblech	49
8869	Abweißblech	49
8870	Abweißblech	49
8871	Fugenabdeckung	48
8872	Abweißblech	49
8873	Abrolleiste	48
8874	Gurtdurchführung	50
8876	Bürstendichtung	30, 48, 49
8878	Bürstendichtung	30, 41, 46, 48
8879	Bürstendichtung	30, 49
8881	Aufschraubgurtwickler	50
8882	Aufschraubgurtwickler	50
8886	Quaste	49
8887	Zugschnur	49
8890	Feder für Panzer	50
8891	Feder für Panzer	50
8892	Alu-Vorsatzschale	48
8893	Alu-Vorsatzschale	48
8897	Führungsschiene	49
8898	Führungsschiene	49
8899	Halteklipps	41, 42, 49
8910	Kegelradgetriebe	49
8911	Kegelradgetriebe	49
8912	Aluwinkel	28, 48
8913	Aluwinkel	28, 48
8914	Aluwinkel	28, 48
8915	Aluwinkel	28, 48
8929	Aussteifung	48
8930	Achtkantstahlwelle	49
8931	Achtkantstahlwelle	49
8933	Walzenkapsel	49
8934	Walzenkapsel	49
8935	Walzenkapsel	49
8936	Adapter	49
8938	Kugellager	49
8939	Verbindungsflasche	49
8940	PVC-Rollostab	50
8941	Alu-Rollostab	50
8943	Alu-Abschluss-Stab	50
8944	Arretierung	50
8945	Alu-Abschluss-Stab	50
8946	PVC-Rollostab	50
8950	PVC-Rollostab	50

Art.-Nr.	Benennung	Seiten
8951	Alu-Rollostab	50
8954	Arretierung	50
8955	Alu-Abschluss-Stab	50
8956	PVC-Rollostab	50
8958	Anschlag-/Endstopfen	50
8960	Insektengitter	49
8961	Insektengitter	49
8963	Aluabdeckung Fliegengitter	49
8966	Bürstendichtung	30
8970	Insektengitter	49
8971	Befestigungsscheibe	49
8972	Verbindungsflasche	49
8974	Verbindungsflasche	49
8975	Verbindungsflasche	49
8978	Verbindungsflasche	49
8979	Verbindungsflasche	49
8980	Schallschutzdämmung	50
8981	Schallschutzdämmung	50
8982	Schallschutzdämmung	50
8983	Schallschutzdämmung	50
8984	Schallschutzdämmung	50
8986	Dämmung	50
8987	Dämmung	50
GKV 1	Schwelle	18
GKV 2	Bürstendichtung	18
GKV 3	Anschlagleiste	18

Systemdiagramm · System Chart

